

A UNIVERSE
OF DESIGN
FLEXIBILITY

ECOPHON FOCUS™



Ecophon®
SAINT-GOBAIN

A SOUND EFFECT ON PEOPLE

Contents

04 ABOUT ECOPHON

06 GOOD ACOUSTICS MATTER EVERYWHERE

08 SUSTAINABILITY AS A GUIDING LIGHT

10 A UNIVERSE OF DESIGN FLEXIBILITY WITH ECOPHON FOCUS™

12 ECOPHON FOCUS PRODUCT RANGE

- 16 Focus A
- 16 Focus B
- 17 Focus Ds
- 17 Focus Dg
- 18 Focus D/A
- 18 Focus E
- 19 Focus Ez
- 19 Focus F
- 20 Focus Lp
- 20 Focus SQ
- 21 Focus Levels
- 21 Focus Flexiform A
- 22 Focus Edge 500
- 23 Focus Fixiform E
- 23 Focus Fixiform Ds
- 24 Focus Frieze
- 24 Focus Wing
- 25 Square 43
- 26 Dot
- 27 Line

28 COLOURS AND SURFACES

30 ECOPHON FOCUS OVERVIEW

32 SYSTEM PROPERTIES

Acoustics, technical properties and installation diagrams

This publication shows products from Ecophon product range and those of other suppliers. The specifications are intended to provide a general guide to which products are most suitable for the preferences indicated. Technical data is based on results obtained under typical testing conditions or long experience in normal conditions. The specified functions and properties for products and systems are only valid on condition that instructions, installation diagrams, installation guides, maintenance instructions and other stated conditions and recommendations have been taken into consideration and followed. Deviation from this, such as changing specific components or products, will mean that Ecophon cannot be held responsible for the function, consequences and properties of the products. All descriptions, illustrations and dimensions contained in this brochure represent general information and shall not form part of any contract. Ecophon reserves the right to change products without prior notice. We disclaim any liability for misprints. For the latest information go to www.ecophon.com or contact your nearest Ecophon representative.





Sound of nature

IN EVERYDAY LIFE

Saint-Gobain Ecophon contributes to good indoor environments for working, healing and learning. We do this by developing, manufacturing and delivering acoustic products and systems designed around the natural evolution of human hearing – replicating the outdoor sound experience indoors, because that’s just better for people.

Having a sound effect on people, in every way we can, is what we do proudly. That promise makes every one of us a passionate advocate for the importance of room acoustics to people’s wellbeing – whatever the space, activity or need.

Good acoustics

MATTER EVERYWHERE

The importance of acoustics is underappreciated. Sound impacts us in daily life, and the scientific support for improving our indoor sound environments is well-documented.

And what exactly is an ideal indoor sound environment for people? One based on how we experience sound outside. The human auditory sense is naturally adapted to an outdoor environment where there is not any sound reflections from ceilings and walls.

That's why most of what we do at Ecophon is about replicating the acoustic qualities found in nature for indoor environments. We want to optimise indoor spaces to our natural way of hearing, so that speech and sound is easy to hear and understand, when needed, improving performance and wellbeing.

Usually that starts with the ceiling. A wall-to-wall acoustic ceiling is the easiest way to get a large sound-absorbing surface area into a space, and is usually the best way to reduce sound strength, shorten reverberation times, and increase speech clarity and overall hearing comfort.

But for a truly optimal sound environment, you'll also likely need different kinds of sound absorbers placed strategically throughout the space—wall-mounted panels and free-standing dividers are just two examples. In other words, a holistic approach is the best way to reduce the overall sound level and sound propagation in a room. Ecophon is here to help.

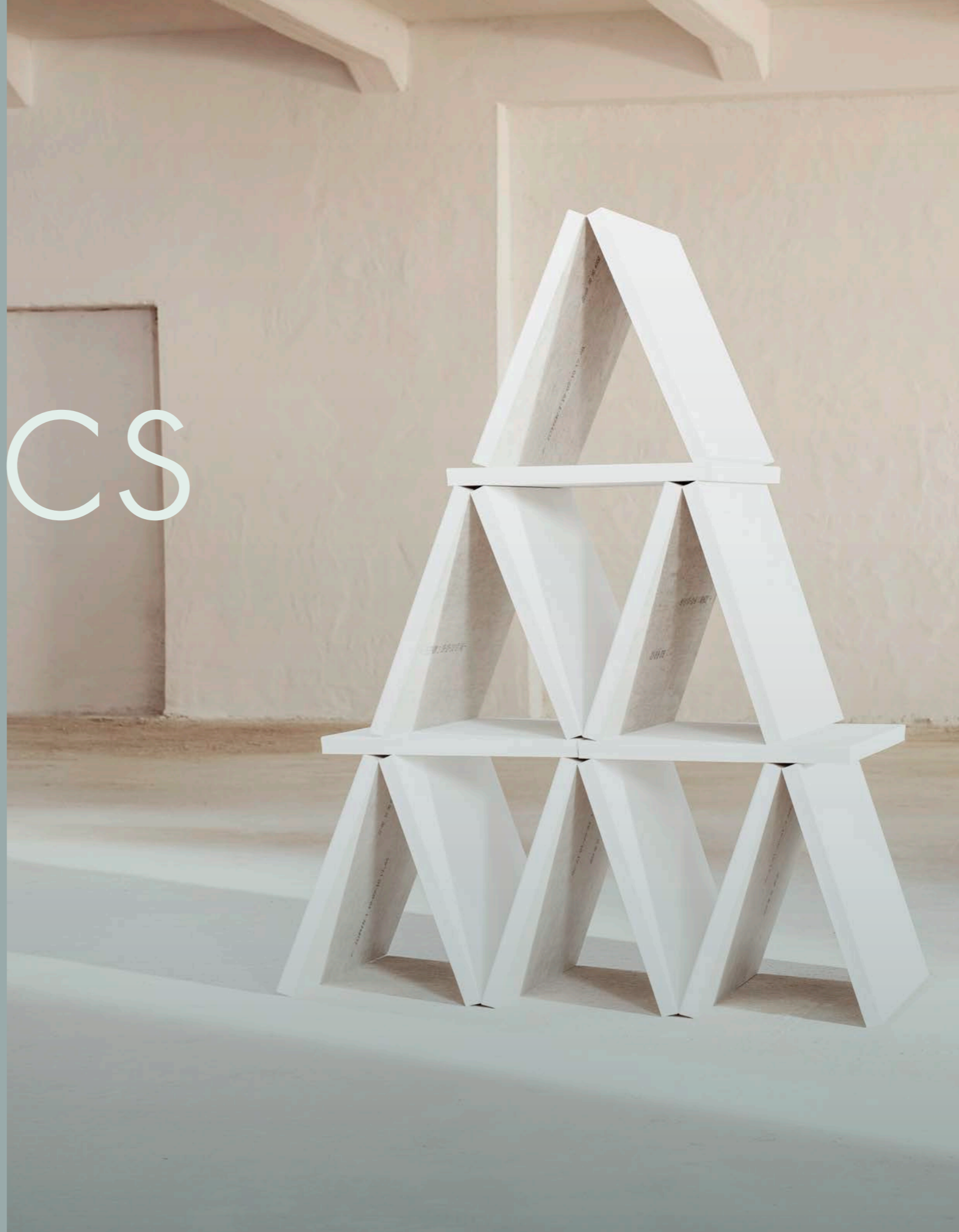



Sustainability

AS A GUIDING LIGHT

At Ecophon, sustainability is at the core of who we are and how we work. It's a promise to do better every day, in every way, for our co-workers, customers and partners in all walks of life. It's an approach to innovation that always sides with nature, and that takes its cue from the needs and environments of the people who will ultimately benefit from it. And it's a commitment to take as little as possible to do more than expected, so that future generations get to experience this planet at its life-sustaining best.

We are proud that all our products are united by their sustainability-driven origins. That applies to the materials we choose, but also to everything from the clean energy we use in our production facilities to the transparency, traceability and accountability embedded in every stage of product and service development, from idea to innovation. This is what makes us reach an industry-low carbon footprint. Because credible sustainability demands a holistic effort that leaves no challenge unaddressed, no opportunity unexplored. And fulfills the promise that ultimately drives all of us at Ecophon – to have a sound effect on people.



ecophon FOCUS™

A UNIVERSE OF DESIGN FLEXIBILITY

Ecophon Focus™ is our most comprehensive system family and supports a range of opportunities through different edge designs, forms, levels and installation options.

- Absorption class A
- 10 different edge options in addition to 6 unique solutions
- Premium surface with superior quality and a matte look

Focus is a great choice for cellular offices, corridors, receptions, entrance halls, waiting rooms, team work spaces and other public areas where visual appeal and sound quality are equally important.

The Focus family includes panels that can be fixed directly to soffit. That gives you options for spaces that might seem challenging or impossible to improve acoustically, such as stairwells, basements and spaces with low ceiling height.



Minimum
51%
post-consumer recycled
content

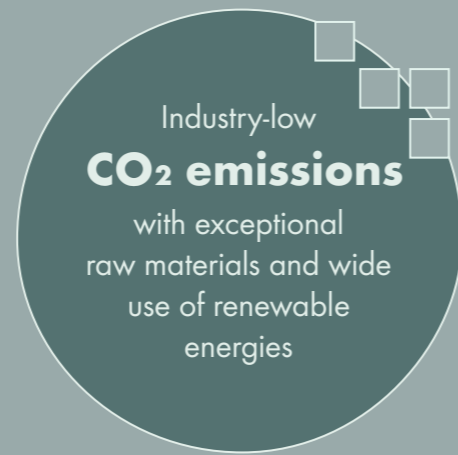

ECOPHON FOCUS™ PRODUCT RANGE

Focus is suspended wall-to-wall ceilings with excellent acoustic properties, appealing looks and the flexibility to suit every need make the Focus family the perfect toolbox.

The Focus family includes six unique complementary solutions for level changes, wall endings and free-hanging ceilings. They are designed to give the

ceiling an integrated appearance that enhances the overall aesthetic appeal.

Focus Levels gives you still more design options. With Levels, you combine a variety of panel thicknesses and sizes to give a ceiling or wall its own uniquely staggered look and feel.

FOCUS D/A

1720x600x20
2000x600x20
2400x600x20



FOCUS E

600x600x20
1200x600x20
1200x1200x20
1600x600x20
1800x600x20
2000x600x20
2400x600x20

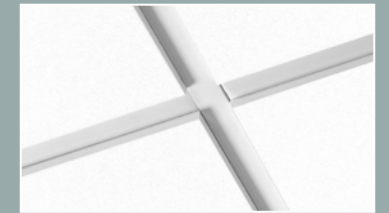

FOCUS Ez

600x600x40



FOCUS F

600x600x20
1200x600x20



FOCUS A

600x600x20
1200x600x20
1200x1200x20
1600x600x20
1800x600x20
2000x600x20
2400x600x20

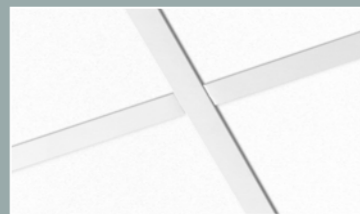

FOCUS B

600x600x20
1200x600x20

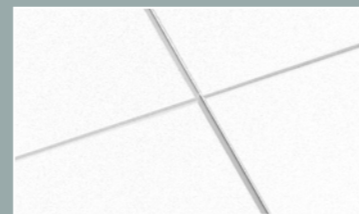

FOCUS Lp

600x150x20
600x300x20
600x600x20
1200x150x20
1200x300x20
1200x600x20
1800x600x20



FOCUS SQ

600x600x20
1200x600x20

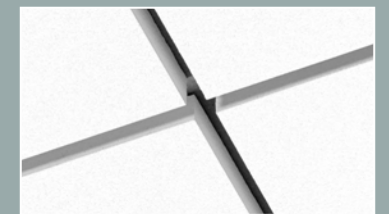

FOCUS Ds

600x600x20
1200x600x20
1200x1200x20
1600x600x20
1800x600x20
2000x600x20
2400x600x20

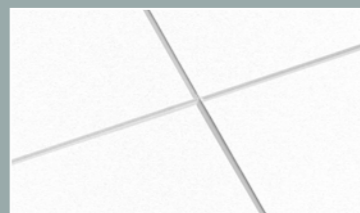

FOCUS Dg

600x600x20
1200x600x20
1200x1200x25
1600x600x20
1800x600x20
2000x600x20
2400x600x20

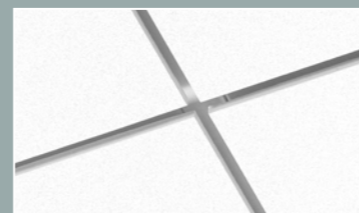

FOCUS LEVELS

600x600x20
1200x600x20
1200x300x20
600x600x30
1200x600x30
1200x300x30
600x600x40
1200x300x40



FOCUS FLEXIFORM A

1200x600x30
1600x600x30
2000x600x30
2400x600x30



FOCUS FIXIFORM E

1200x600x20



FOCUS FIXIFORM D_s

1200x600x20
1500x600x20
1900x600x20
2300x600x20



FOCUS FRIEZE

2400x600x20



FOCUS EDGE 500

600x600x20
1200x600x20
1200x1200x20
1200x1200x25

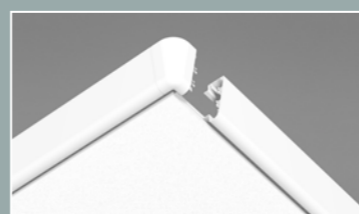

FOCUS WING

600x200x50
1200x200x50



SQUARE 43

Edge D_s, D_g, E:
600x600x20



Edge E_z:
600x600x40

DOT

Edge D_s, D_g, E:
600x600x20



Edge E_z:
600x600x40

LINE

Edge L_p:
1200x150x20
1200x300x20



Edge D_s, D_g, E:
1200x600x20





FOCUS A
Visible grid system and easy demountable tiles. Available in many formats.

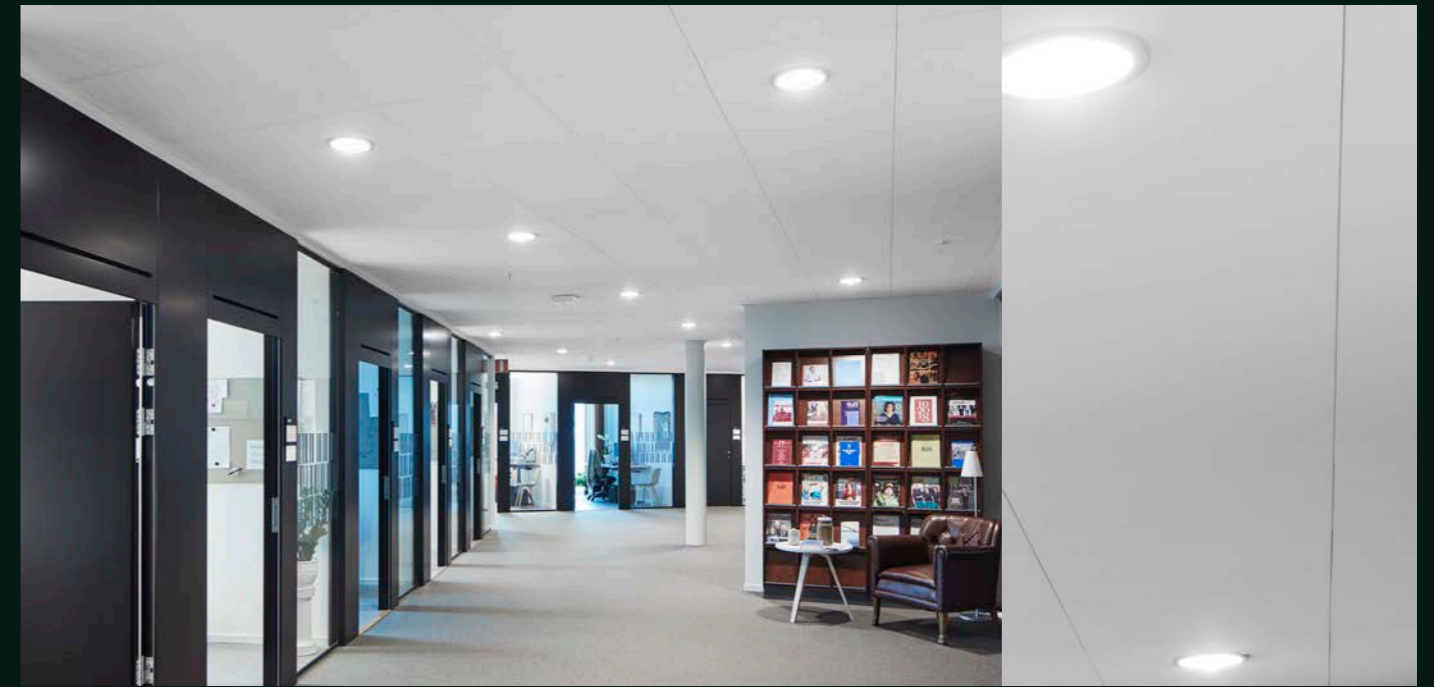

FOCUS D_s
Bevelled edges that generates a discreet groove between the tiles. Concealed grid system.

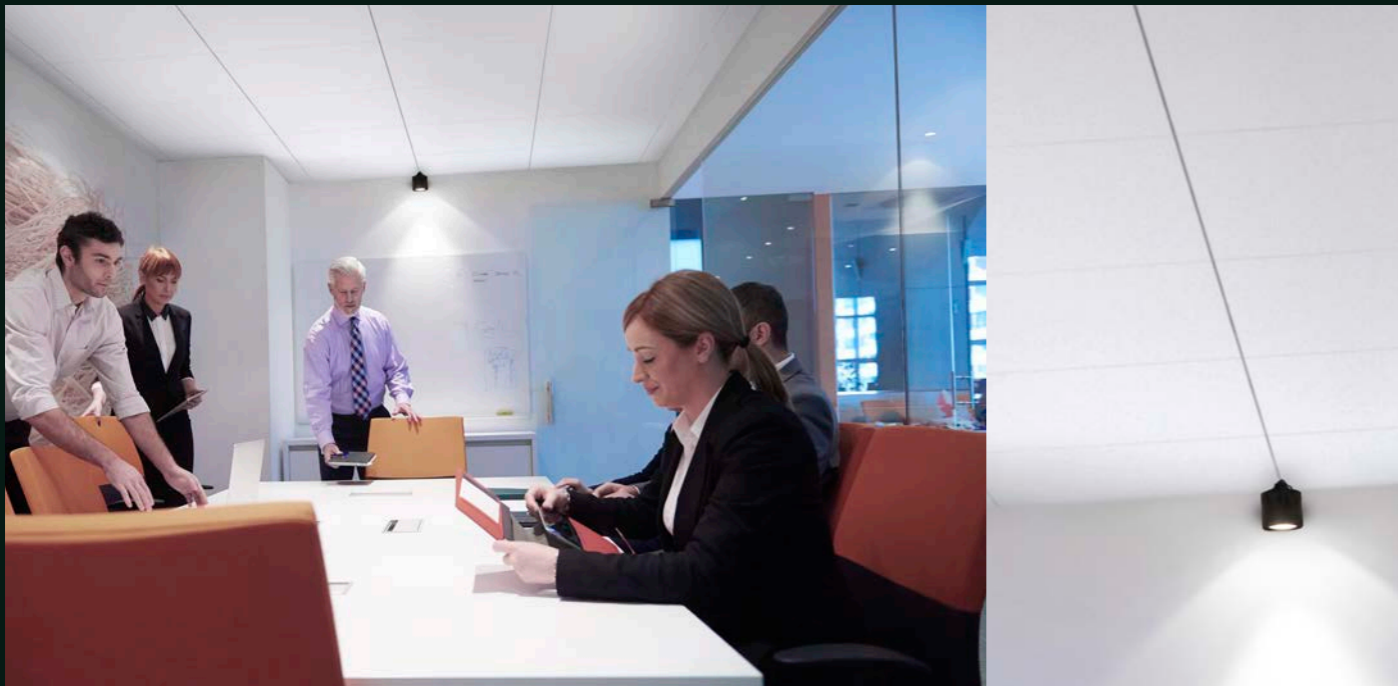
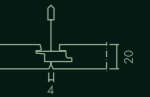

FOCUS B
For direct fixing with glue, ideal for installations that require minimum depth of system.

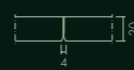

FOCUS D_g
Unique edge design with concealed support edges and a floating appearance.

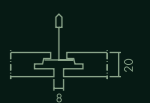

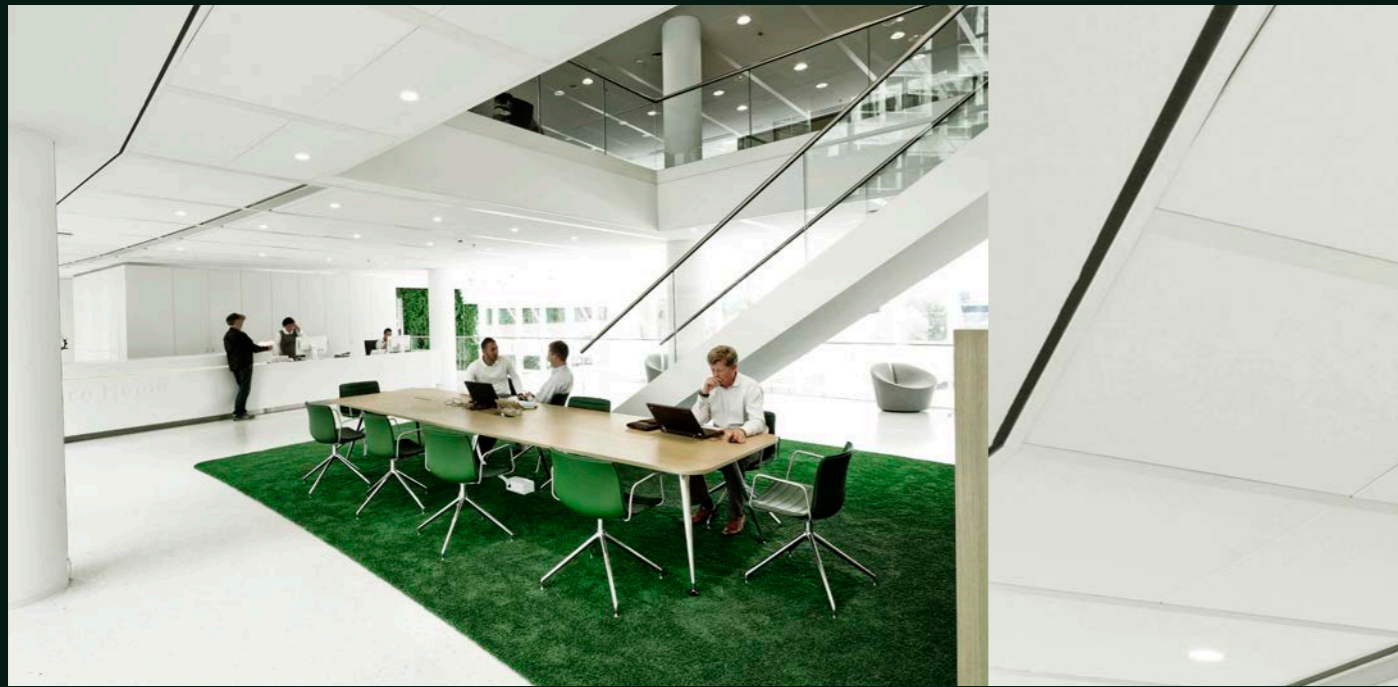

FOCUS D/A
For corridors and bandrastrer solutions. Long panels with a concealed grid system.

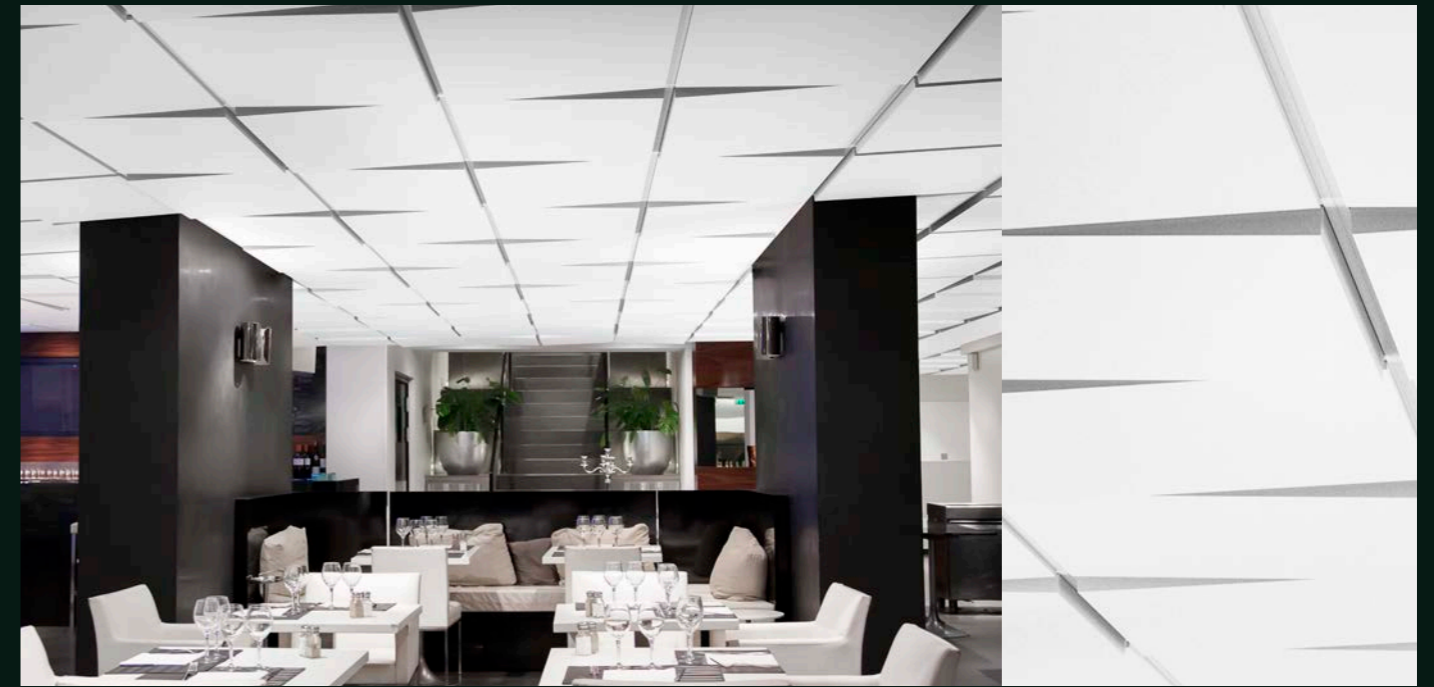

FOCUS E_z
With support edges in different levels enabling a tilted appearance and unique designs.

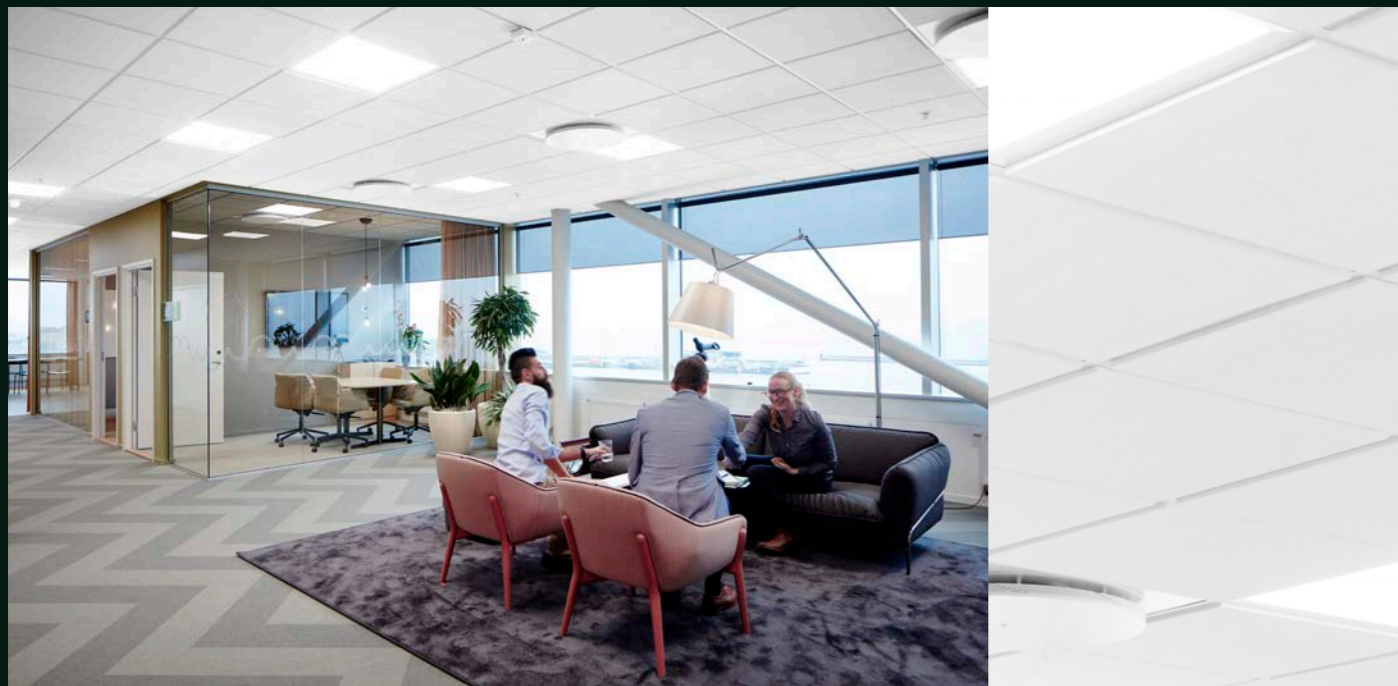
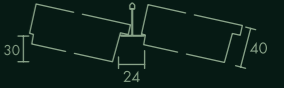

FOCUS E
Recessed visible grid system creating a shadow effect on the edge. Easily demountable tiles.

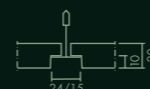

FOCUS F
For direct fixing with screws, ideal for installations that require minimum depth of system.

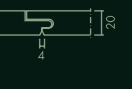

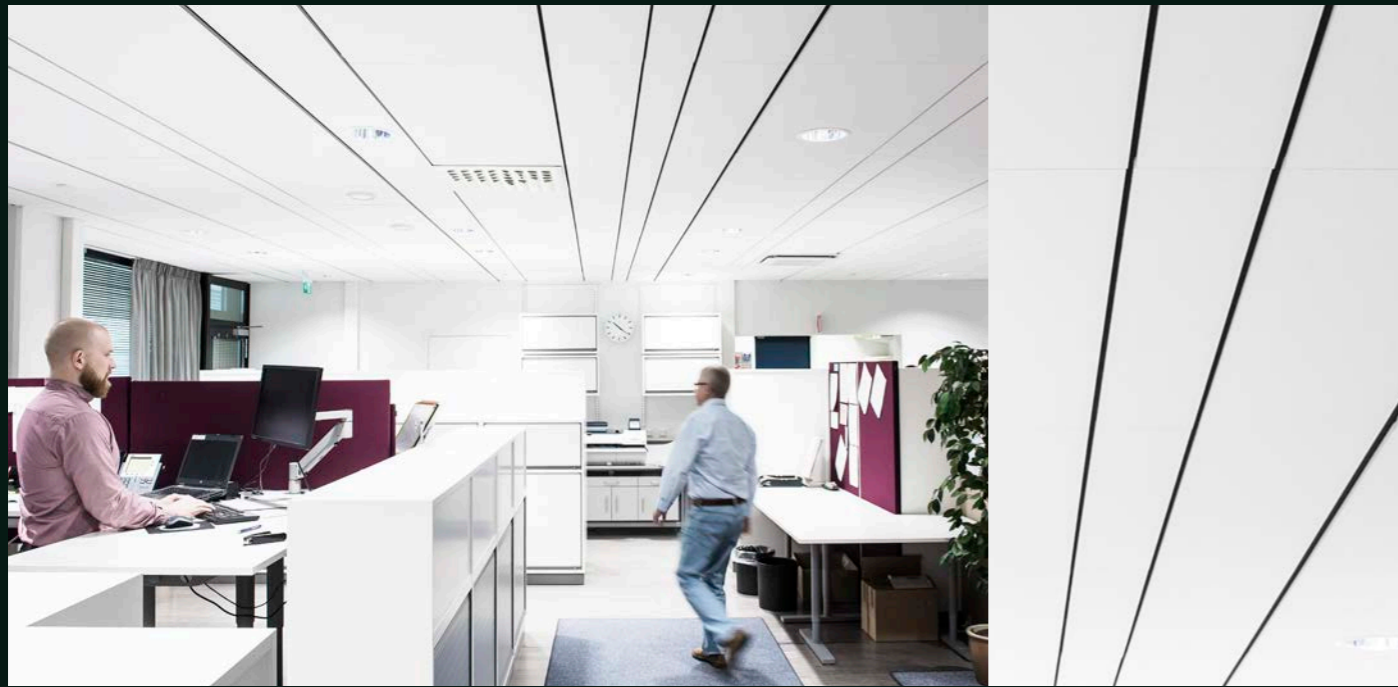

FOCUS Lp
A patented system designed to create long rows in the ceiling, highlighting a specific direction in the room.

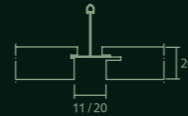

FOCUS LEVELS
Different panel thicknesses within the system for creating unique patterns on walls and ceilings.

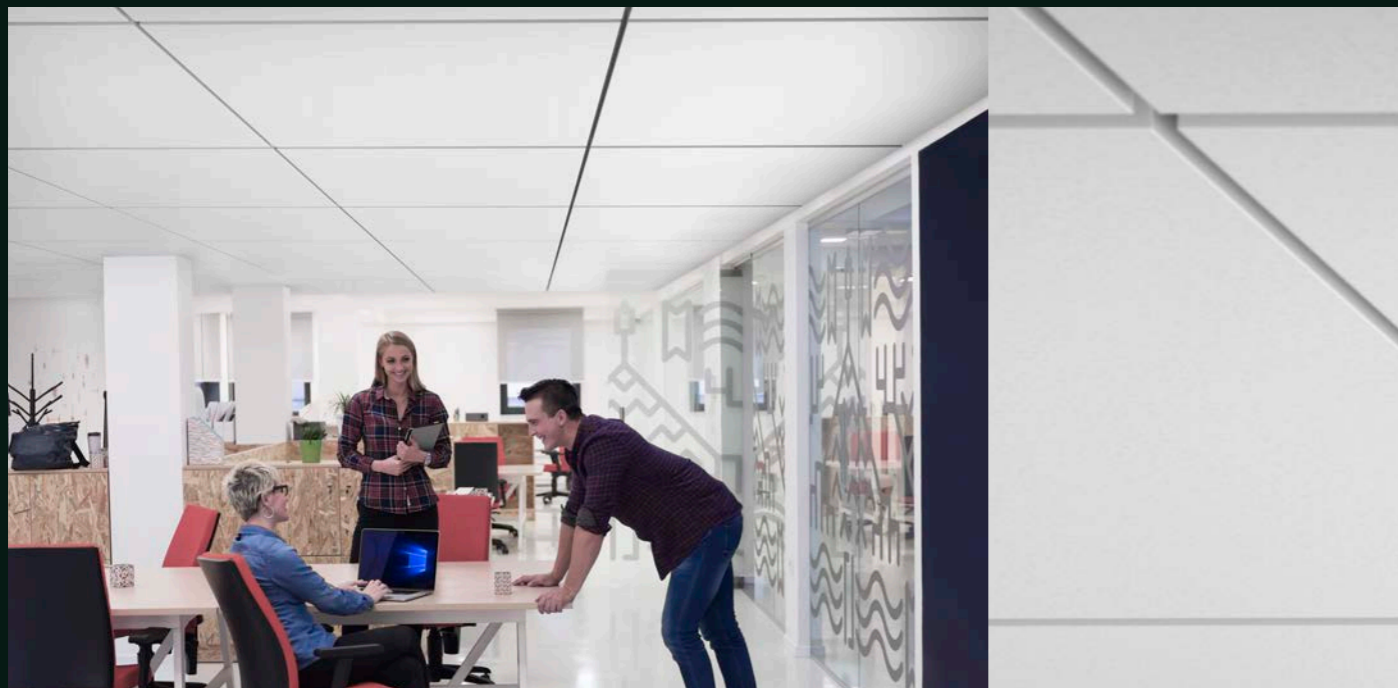

FOCUS SQ
For direct fixing with glue. Installed with a gap between each tile.

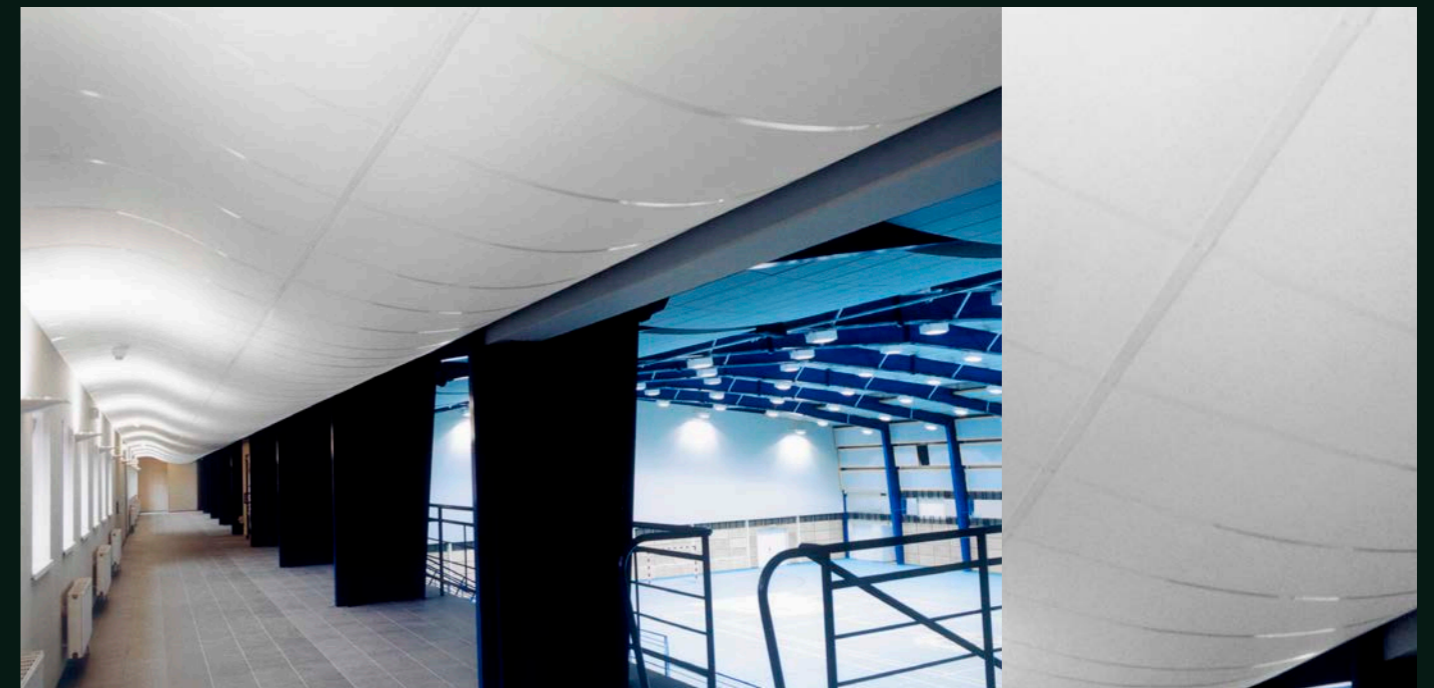

FOCUS FLEXIFORM A
Flexible panels that can be shaped into concave or convex forms.

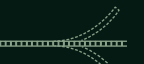



FOCUS EDGE 500
Edge profile for island installations. Profile in extruded aluminium and corners in cast zinc.

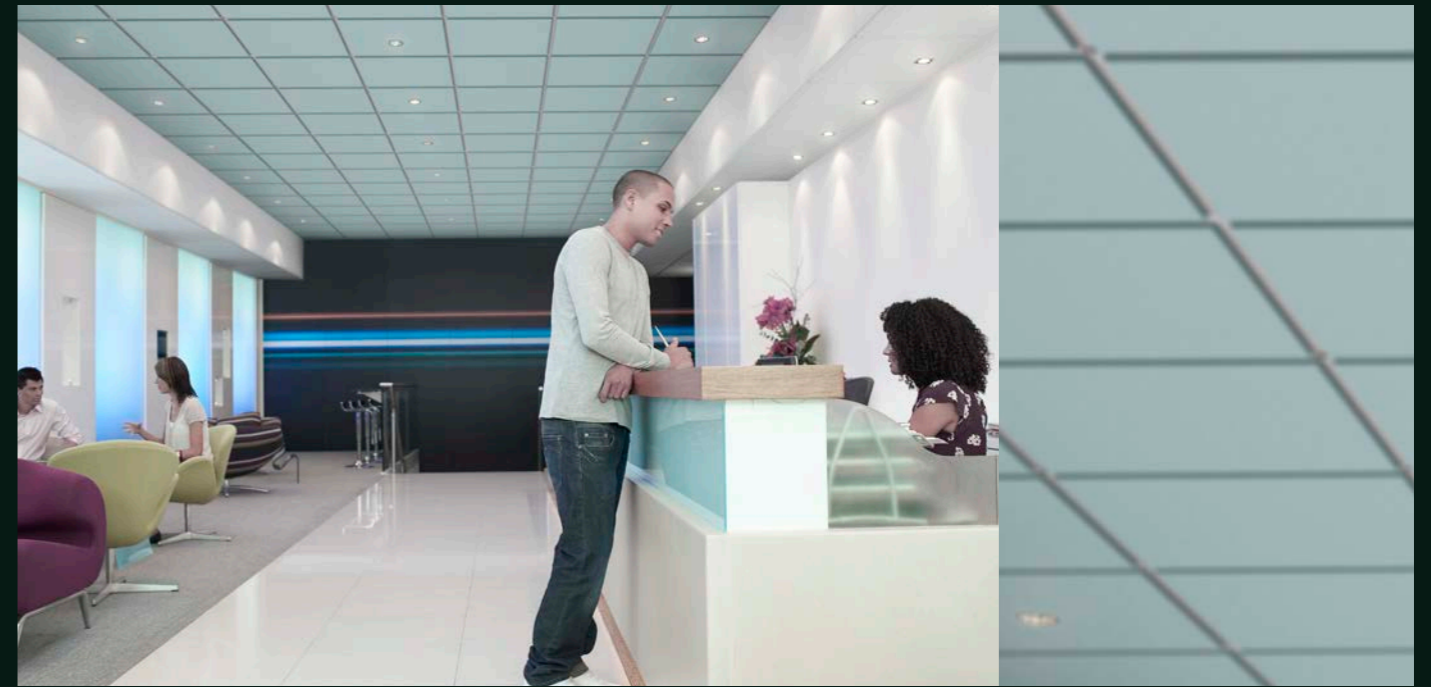

FOCUS FIXIFORM E
Foldable tiles for smooth transitions where there are level shiftings in the ceiling.

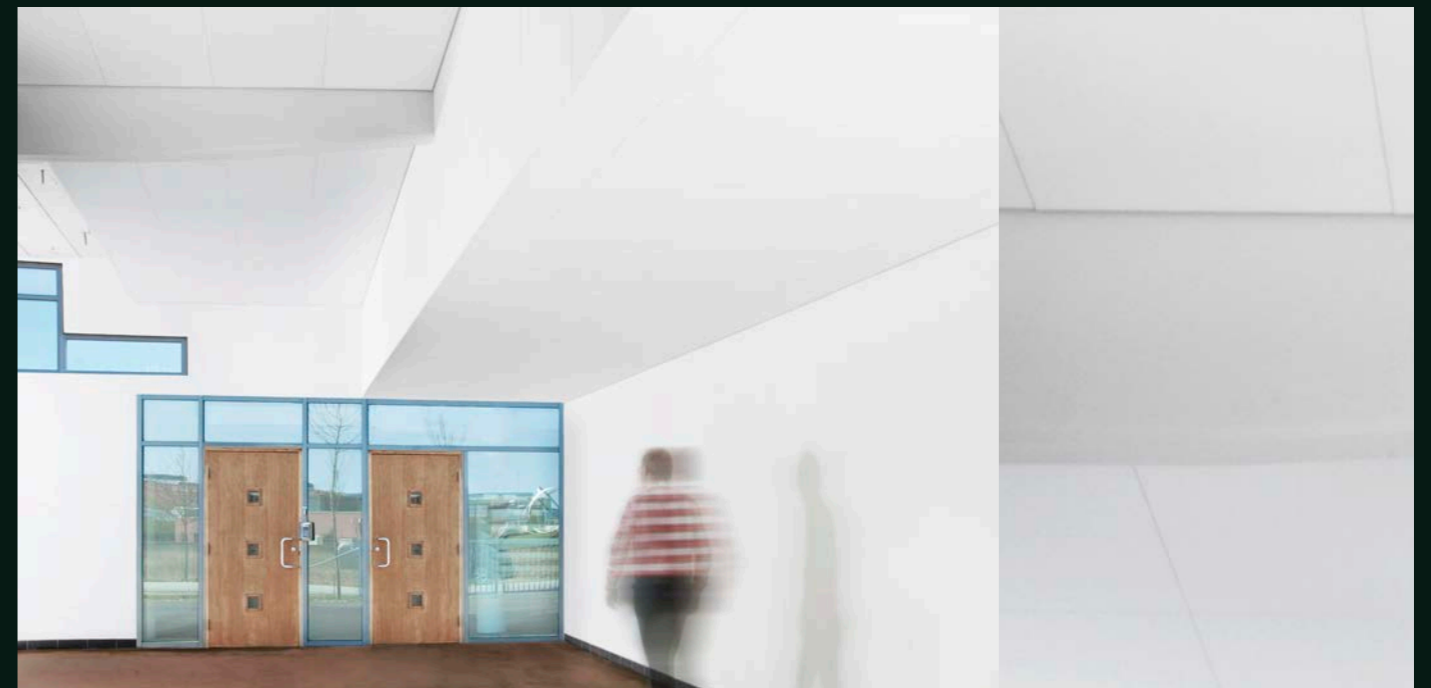
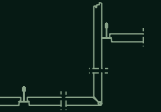

FOCUS FIXIFORM Ds
Foldable tiles for smooth transitions where there are level shiftings in the ceiling.

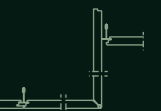



FOCUS FRIEZE
End panels for creating a smooth transition between the ceiling and the wall.

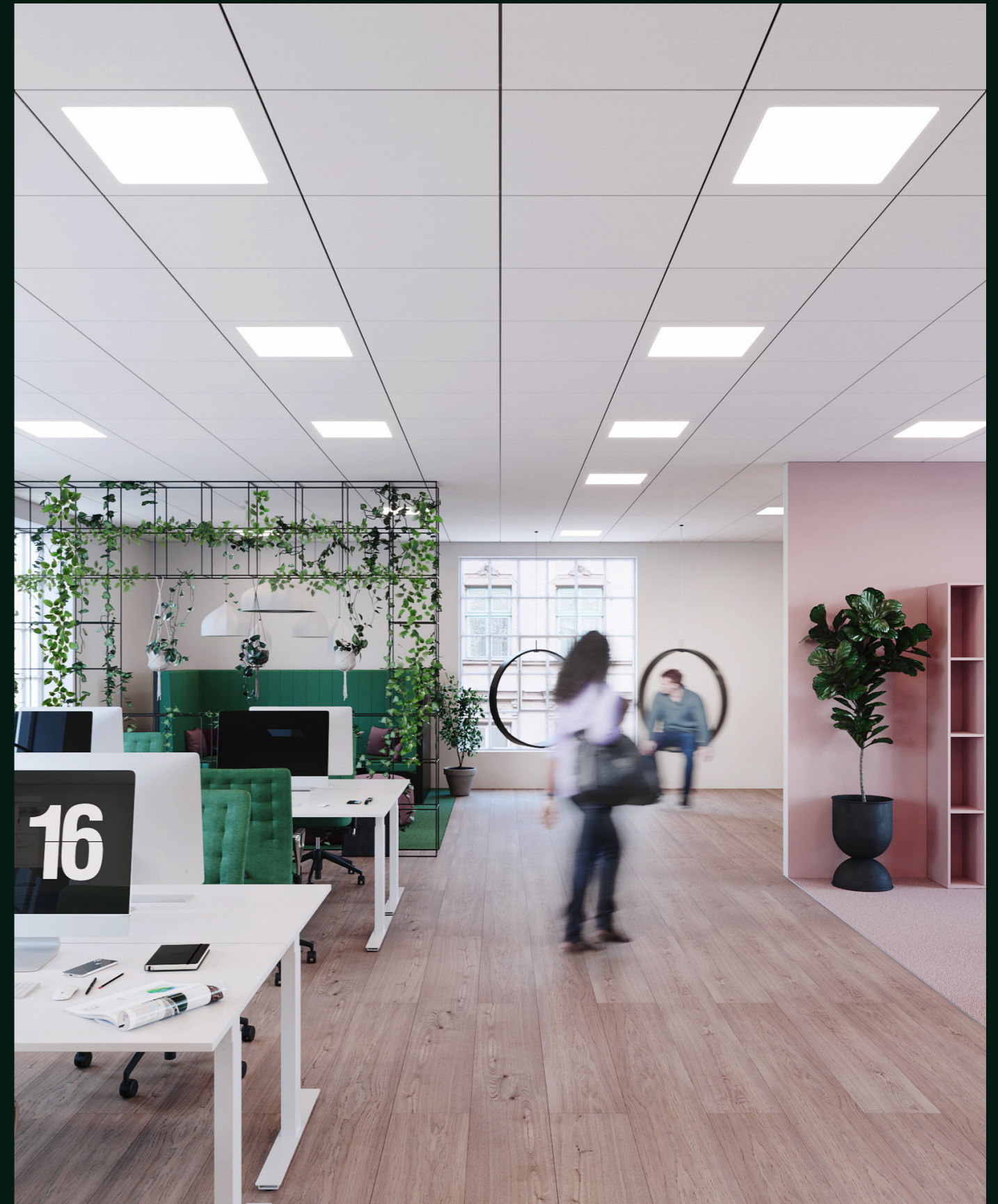

SQUARE 43
Great lighting comfort and low UGR value.

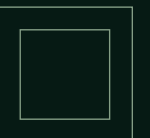

FOCUS WING
Wing shaped absorbers for free hanging suspended ceilings.





DOT
Great lighting comfort and low UGR value.



LINE
The luminaire has great lighting comfort and adds a distinct direction to the ceiling.

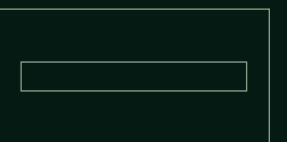

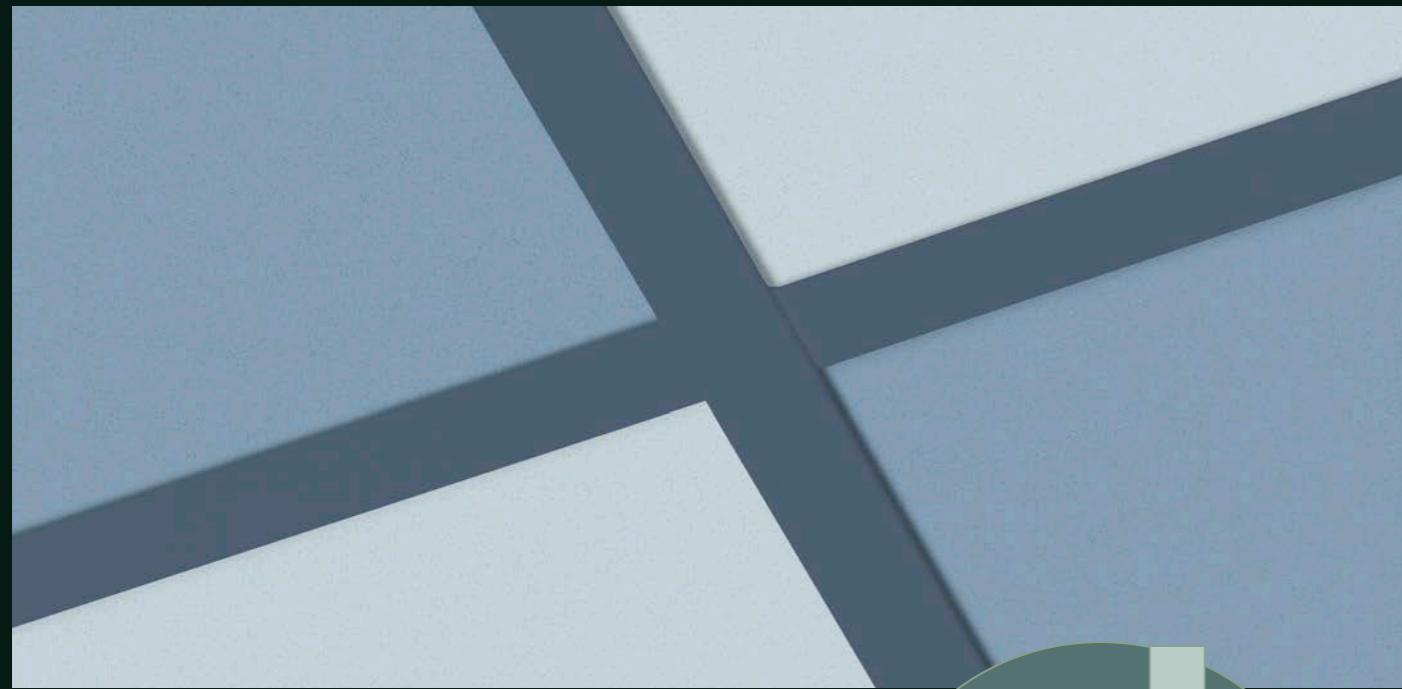

GRID COLOURS

- 15 colour options for grids
- Create your own design
- Closest Akutex FT match creates subtle pattern and mixing FT colours gives more design effect

An acoustic ceiling is often the largest continuous surface in a room. It will affect not only the entire look and feel of the interior, but also the end-users' wellbeing.

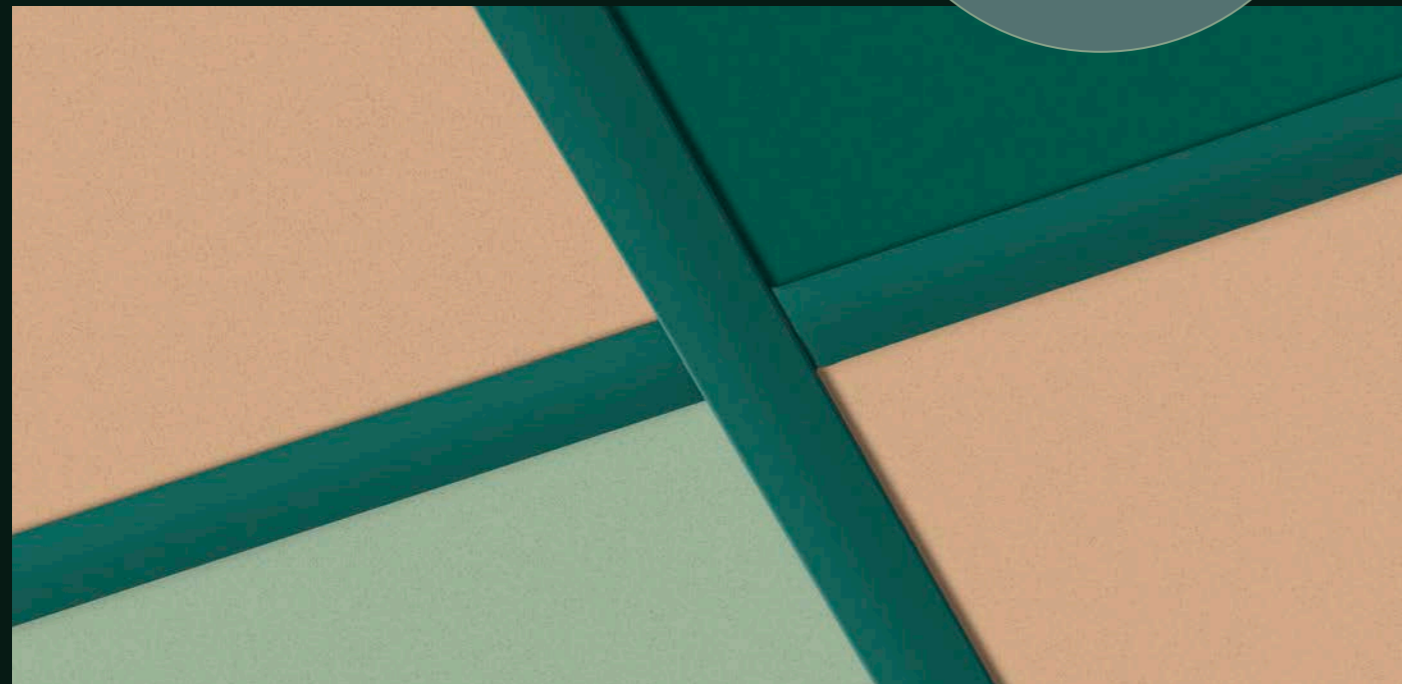

COLOURS AND SURFACES

AKUTEX™ FT

The Akutex label guarantees that the product carrying it has a superior surface technology. Our research and development will always focus on visual aspects, acoustic properties, working environment, architectural trends and environmental aspects. This ensures that Akutex is always one step ahead.



WHITE FROST | Light reflectance 85%.
Nearest NCS colour sample S 0500-N.
Grid colour NCS S 1000-N.



OCEAN STORM | Light reflectance 24%.
Nearest NCS colour sample S 4020-R90B.
Grid colour NCS S 4010-R90B.



MORNING DRIZZLE | Light reflectance 69%.
Nearest NCS colour sample S 1002-B.



VOLCANIC ASH | Light reflectance 56%.
Nearest NCS colour sample 2002-Y.



MOONLIGHT SKY | Light reflectance 7%.
Nearest NCS colour sample S 7020-R90B.
Grid colour NCS S 7010-R90B.

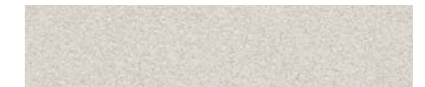

CLOUDY DAY | Light reflectance 62%.
Nearest NCS colour sample S 1500-N.



SILVER STONE | Light reflectance 29%.
Nearest NCS colour sample S 4502-Y.



GOLDEN FIELD | Light reflectance 61%.
Nearest NCS colour sample S 1040-G90Y.



PEACH ROSE | Light reflectance 55%.
Nearest NCS colour sample S 1515-Y80R.
Grid colour NCS S 1510-Y80R.



SILK SLATE | Light reflectance 13%.
Nearest NCS colour sample S 7000-N.
Grid colour NCS S 6500-N.



SUNSET HEAT | Light reflectance 20%.
Nearest NCS colour sample S 2070-Y60R.



HIGHLAND FOG | Light reflectance 55%.
Nearest NCS colour sample S 2005-G.
Grid colour NCS S 2005-G20Y.



GOJI BERRY | Light reflectance 27%.
Nearest NCS colour sample S 3030-Y80R.
Grid colour NCS S 3030-Y80R.



RUBY ROCK | Light reflectance 7%.
Nearest NCS colour sample S 4050-R10B.



SAGE GARDEN | Light reflectance 40%.
Nearest NCS colour sample S 3010-B30G.
Grid colour NCS S 3010-B30G.



SILENT STEAM | Light reflectance 45%.
Nearest NCS colour sample S 2010-B.
Grid colour NCS S 2005-R90B.



EUCALYPTUS LEAF | Light reflectance 23%.
Nearest NCS colour sample S 5010-B30G.
Grid colour NCS S 5010-B30G.



FRESH CLOVER | Light reflectance 35%.
Nearest NCS colour sample S 3020-G40Y.
Grid colour NCS S 3020-G40Y.



SCALLOP SHELLS | Light reflectance 76%.
Nearest NCS colour sample S 0804-Y50R.
Grid colour NCS S 0603-Y60R.



SUMMER FOREST | Light reflectance 10%.
Nearest NCS colour sample S 6030-G10Y.
Grid colour NCS S 6030-G10Y.



WET SAND | Light reflectance 35%.
Nearest NCS colour sample S 3020-Y30R.
Grid colour NCS S 3020-Y40R.











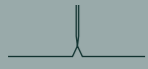
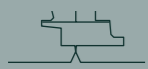





DARK DIAMOND | Light reflectance 4%.
Nearest NCS colour sample S 9000-N.
Grid colour NCS S 8000-N.

NOTE

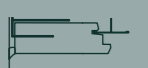
Colours may vary slightly between different production batches. Reproduction of colours vary between print and reality.

ECOPHON FOCUS OVERVIEW

Edge design	Product	Absorption class	Connect grid	Sizes (mm)	Ecophon Lighting	Possible combinations
	Ecophon Focus A	A	T15 / T24	600x600x20, 1200x600x20, 1200x1200x20, 1600x600x20, 1800x600x20, 2000x600x20, 2400x600x20		Ecophon Focus Flexiform A Ecophon Focus Frieze
	Ecophon Focus B	C	Direct fixing	600x600x20 1200x600x20		
	Ecophon Focus Ds	A	T24	600x600x20, 1200x600x20, 1200x1200x20, 1600x600x20, 1800x600x20, 2000x600x20, 2400x600x20	Ecophon Dot Ecophon Square 43 Ecophon Line	Ecophon Focus Edge 500 Ecophon Focus Fixiform Ds Ecophon Focus Frieze Ecophon Focus Wing
	Ecophon Focus Dg	A	T24	600x600x20, 1200x600x20, 1200x1200x25, 1600x600x20, 1800x600x20, 2000x600x20, 2400x600x20	Ecophon Dot Ecophon Square 43 Ecophon Line	Ecophon Focus Edge 500 Ecophon Focus Frieze
	Ecophon Focus D/A	A	T24 Bandraster	1720x600x20, 2000x600x20, 2400x600x20		
	Ecophon Focus E	A	T15 / T24	600x600x20, 1200x600x20, 1200x1200x20, 1600x600x20, 1800x600x20, 2000x600x20, 2400x600x20	Ecophon Dot Ecophon Square 43 Ecophon Line	Ecophon Focus Edge 500 Ecophon Focus Fixiform E Ecophon Focus Frieze Ecophon Focus Wing
	Ecophon Focus Ez	A	T24	600x600x40	Ecophon Dot Ecophon Square 43	
	Ecophon Focus F	C	Direct fixing	600x600x20, 1200x600x20		
	Ecophon Focus Lp	A	T24	600x150x20, 600x300x20, 600x600x20 1200x150x20, 1200x300x20, 1200x600x20 1800x600x20	Ecophon Line	
	Ecophon Focus SQ	C	Direct fixing	600x600x20, 1200x600x20		
	Ecophon Focus Levels	Up to A	Direct fixing, ceiling and wall	600x600x20, 1200x600x20, 1200x300x20, 600x600x30, 1200x600x30, 1200x300x30, 600x600x40, 1200x600x40, 1200x300x40		
	Ecophon Focus Flexiform A	A	T24	1200x600x30, 1600x600x30, 2000x600x30, 2400x600x30		Ecophon Focus A
	Ecophon Focus Fixiform E	A	T24	1200x600x20		Ecophon Focus E
	Ecophon Focus Fixiform Ds	A	T24	1200x600x20, 1500x600x20, 1900x600x20, 2300x600x20		Ecophon Focus Ds
	Ecophon Focus Frieze	A	T24	2400x600x20		Ecophon Focus A Ecophon Focus Ds Ecophon Focus Dg Ecophon Focus E
	Ecophon Focus Edge 500		T24	600x600x20, 1200x600x20, 1200x1200x20 1200x1200x25		Ecophon Focus Ds Ecophon Focus Dg Ecophon Focus E
	Ecophon Focus Wing	A	T24	600x200x50, 1200x200x50		Ecophon Focus Ds Ecophon Focus E



Ecophon Focus panels contribute to a healthy indoor environment with superior acoustic absorption, low VOC emissions in line with the strictest requirements, and a full chemical transparency with verified Health Product Declarations. The low environmental footprint of our Focus panels is third-party verified in Environmental Product Declarations.

The products do not contribute to fire and the glass wool core of the Focus tiles is tested and classified as non-combustible according to EN ISO 1182. Fire classification according to EN 13501-1, see Technical Properties on respectively product.

NOTE
More product and system information such as installation help and sustainability documentation can be found at www.ecophon.com

System properties

ACOUSTICS, TECHNICAL PROPERTIES AND INSTALLATION DIAGRAMS

- 34 Focus A
- 37 Focus B
- 39 Focus Ds
- 42 Focus Dg
- 44 Focus D/A
- 46 Focus E
- 48 Focus Ez
- 50 Focus F
- 52 Focus Lp
- 54 Focus SQ
- 56 Focus Levels
- 58 Focus Flexiform A
- 60 Focus Edge 500
- 62 Focus Fixiform E
- 64 Focus Fixiform Ds
- 66 Focus Frieze
- 68 Focus Wing
- 69 Square 43
- 70 Dot
- 71 Line

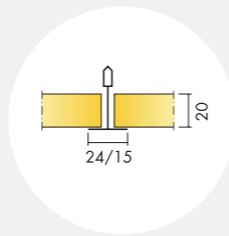

Ecophon Focus™ A

Acoustic

Sound Absorption:

Test results according to EN ISO 354. Classification according to EN ISO 11654, and the single value ratings for Noise Reduction Coefficient, NRC and Sound Absorption Average, SAA according to ASTM C 423.

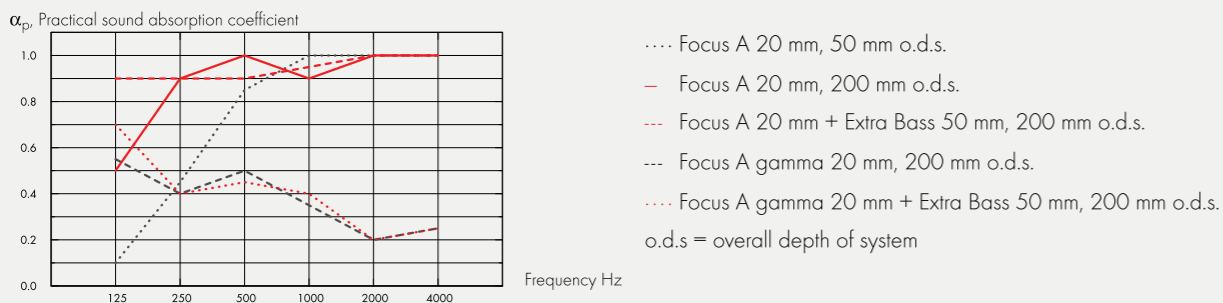

	THK mm	o.d.s. mm	α_p Practical sound absorption coefficient						α_w	Sound absorption class
			125 Hz	250 Hz	500 Hz	1000 Hz	2000 Hz	4000 Hz		
-	20	50	0.10	0.45	0.85	1.00	1.00	1.00	0.75	C
-	20	200	0.50	0.90	1.00	0.90	1.00	1.00	1.00	A
+ Extra Bass,	70	200	0.90	0.90	0.90	0.95	1.00	1.00	0.95	A
gamma	20	200	0.55	0.40	0.50	0.35	0.20	0.25	0.30	D
gamma+ Extra Bass	70	200	0.70	0.40	0.45	0.40	0.20	0.25	0.30	D

	THK mm	o.d.s. mm	NRC	SAA
-	20	50	0.85	0.83
+ Extra Bass,	70	200	0.93	0.93
gamma	20	200	0.35	0.36
gamma+ Extra Bass	70	200	0.35	0.37
-	20	400	0.85	0.88

THK mm	AC(1.5) Articulation Class, ASTM E1111, ASTM E1110	D_{nfw} Weighted normalized flanking level difference, ISO 10848-2	CAC dB Ceiling Attenuation Class, ASTM 1414, ASTM E413
20	190	20	21

Indoor Air Quality:

Certificate / Label	Standard	Plant
Eurofins Indoor Air Comfort®	IAC	IAC Gold
French VOC	A	A+
Finnish M1	•	•

Environmental Footprint: Focus A: 3,13 (Focus family EPD in conformity with ISO 14025 / EN 15804) , Focus A/Plant: 1,81 (Focus A/Plant EPD in conformity with ISO 14025 / EN 15804),

Circularity: Minimum post-consumer recycled content: 52%, Recyclability: Fully recyclable,

Fire safety: The glass wool core of the tiles is tested and classified as non-combustible according to EN ISO 1182. Europe: EN 13501-1, A2-s1,d0,

Humidity Resistance: According to EN 13964:2014 Standard: Class C, RH 95% and 30°C, Plant: Class A, RH 70% and 25°C,

Visual appearance: White Frost, nearest NCS colour sample S 0500-N, 85% light reflectance. Gloss < 1.

Cleanability: Daily dusting and vacuum cleaning. Weekly wet wiping.

Accessibility: The tiles are easily demountable. Minimum demounting depth according to installation diagrams.

Installation: Installed according to installation diagrams, installation guides and drawing aid. For information regarding minimum overall depth of system see quantity specification.

System weight: The weight of the system (including suspension grid) should be approximately 3 kg/m².

Mechanical properties: See table about Max live load and Min load bearing capacity and Functional demands, Mechanical properties at www.ecophon.com.

CE: Ecophon ceiling systems are CE marked according to the European harmonized standard EN13964:2014. CE marked construction products are covered by a Declaration of Performance (DOP) which enables customers and users to easily compare performance of products available on the European market.

Installation diagram in detail www.ecophon.com

M01
Installation diagram (M01) for Ecophon Focus A

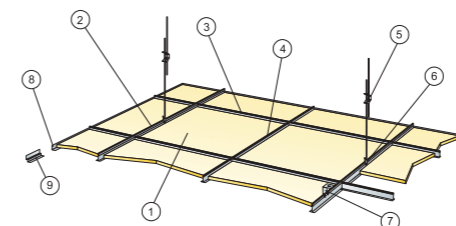

© Ecophon Group

M01 DIN
Installation diagram (M01) for Ecophon Focus A

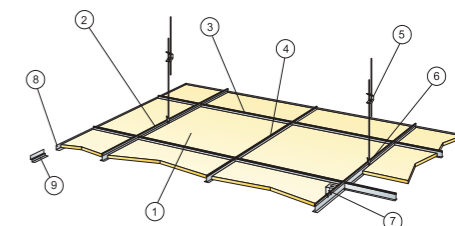

© Ecophon Group

M16
Installation diagram (M16) for Ecophon Focus A XL in corridors

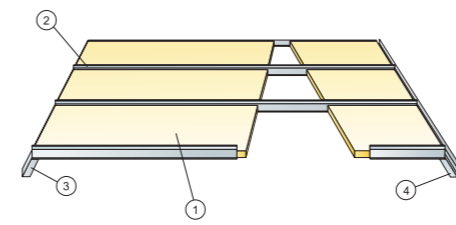

© Ecophon Group

M46
Installation diagram (M46) for Ecophon Focus A XL

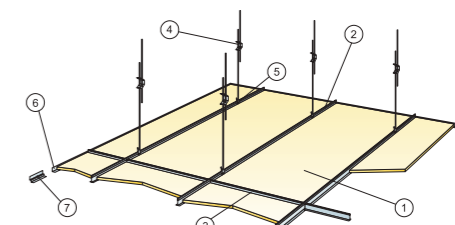

© Ecophon Group

M399
Installation diagram (M399) for Ecophon Focus A

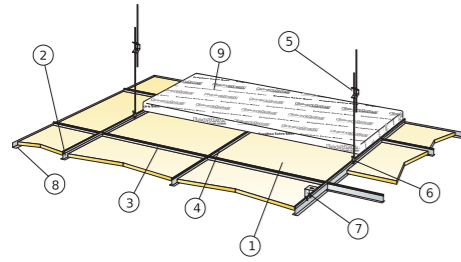

© Ecophon Group

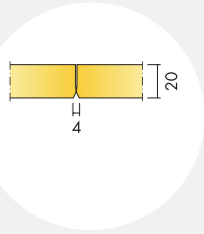

Ecophon Focus™ B

Acoustic

Sound Absorption:

Test results according to EN ISO 354. Classification according to EN ISO 11654, and the single value ratings for Noise Reduction Coefficient, NRC and Sound Absorption Average, SAA according to ASTM C 423.

α_p , Practical sound absorption coefficient

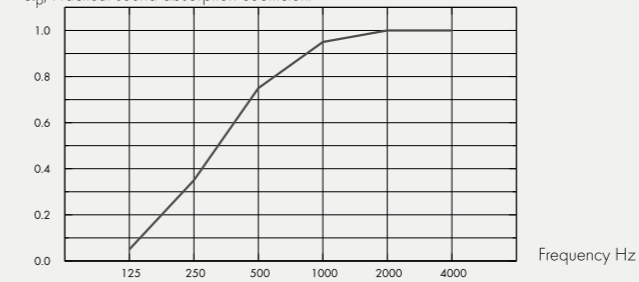

– Focus B 20 mm, 20 mm o.d.s.
o.d.s = overall depth of system

THK mm	o.d.s. mm	α_p , Practical sound absorption coefficient						α_w	Sound absorption class
		125 Hz	250 Hz	500 Hz	1000 Hz	2000 Hz	4000 Hz		
20	20	0.05	0.35	0.75	0.95	1.00	1.00	0.65	C

THK mm	o.d.s. mm	NRC	SAA	
-	20	20	0.80	0.78

Indoor Air Quality:

Certificate / Label	Standard	Plant
Eurofins Indoor Air Comfort®	IAC	IAC Gold
French VOC	A	A+
Finnish M1	•	•

Environmental Footprint: Focus B: 3,13 (Focus family EPD in conformity with ISO 14025 / EN 15804) , Focus B/Plant: 2,87 (Focus B/Plant EPD in conformity with ISO 14025 / EN 15804),

Circularity: Minimum post-consumer recycled content: 52%, Recyclability: Fully recyclable,

Fire safety: The glass wool core of the tiles is tested and classified as non-combustible according to EN ISO 1182. Europe: EN 13501-1, A2-s1,d0,

Humidity Resistance: According to EN 13964:2014 Standard: Class C, RH 95% and 30°C, Plant: Class A, RH 70% and 25°C,

Visual appearance: White Frost, nearest NCS colour sample S 0500-N, 85% light reflectance. Gloss < 1.

Cleanability: Daily dusting and vacuum cleaning. Weekly wet wiping.

Accessibility: The tiles are not demountable.

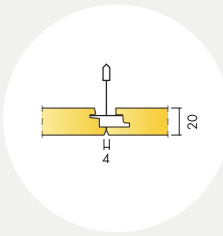

Ecophon Focus™ Ds

Installation: Installed according to installation diagrams, installation guides and drawing aid. For information regarding minimum overall depth of system see quantity specification. Rendered surfaces must have sufficient strength to be able to carry the load imposed by the tiles. If doubts, test gluing should be carried out. The surface should always be dry and clean. For best result the surface should be even.

System weight: The weight of the system should be approximately 2,5 kg/m²

Mechanical properties: Additional live load has to be fixed to the soffit.

CE: Ecophon ceiling systems are CE marked according to the European harmonized standard EN13964:2014. CE marked construction products are covered by a Declaration of Performance (DOP) which enables customers and users to easily compare performance of products available on the European market.

Installation diagram in detail www.ecophon.com

M03
Installation diagram (M03) for Ecophon Focus B, using Connect Absorber glue

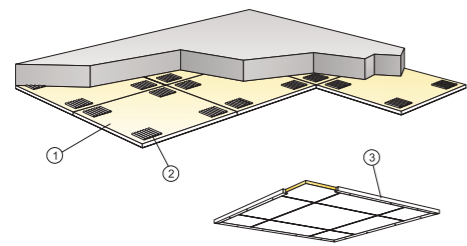

© Ecophon Group

Acoustic

Sound Absorption:

Test results according to EN ISO 354. Classification according to EN ISO 11654, and the single value ratings for Noise Reduction Coefficient, NRC and Sound Absorption Average, SAA according to ASTM C 423.

α_p , Practical sound absorption coefficient

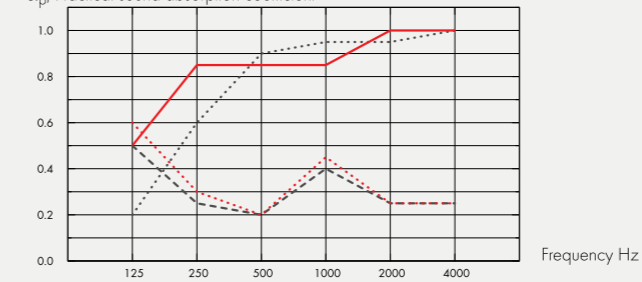

- Focus Ds 20 mm, 65 mm o.d.s.
 - Focus Ds 20 mm, 200 mm o.d.s.
 - Focus Ds gamma 20 mm, 200 mm o.d.s.
 - · - · Focus Ds gamma 20 mm + Extra Bass 50 mm, 200 mm o.d.s.
- o.d.s = overall depth of system

	THK mm	o.d.s. mm	α_p , Practical sound absorption coefficient					α_w	Sound absorption class	
			125 Hz	250 Hz	500 Hz	1000 Hz	2000 Hz			4000 Hz
-	20	65	0.20	0.60	0.90	0.95	0.95	1.00	0.90	A
-	20	200	0.50	0.85	0.85	0.85	1.00	1.00	0.90	A
gamma	20	200	0.50	0.25	0.20	0.40	0.25	0.25	0.25	E
gamma+ Extra Bass	70	200	0.60	0.30	0.20	0.45	0.25	0.25	0.25	E

	THK mm	o.d.s. mm	NRC	SAA
-	20	65	0.90	0.89
gamma	20	200	0.30	0.28
gamma+ Extra Bass	70	200	0.30	0.29
-	20	400	0.80	0.82

THK mm	AC(1,5) Articulation Class, ASTM E1111, ASTM E1110	D_{nfw} Weighted normalized flanking level difference, ISO 10848-2	CAC dB Ceiling Attenuation Class, ASTM 1414, ASTM E413
20	180	24	25

Indoor Air Quality:

Certificate / Label	Standard	Plant
Eurofins Indoor Air Comfort®	IAC	IAC Gold
French VOC	A	A+
Finnish M1	•	•

Environmental Footprint: Focus Ds: 3,13 (Focus family EPD in conformity with ISO 14025 / EN 15804), Focus Ds/Plant: 2,76 (Focus Ds/Plant EPD in conformity with ISO 14025 / EN 15804),

Circularity: Minimum post-consumer recycled content: 52%, Recyclability: Fully recyclable,

Fire safety: The glass wool core of the tiles is tested and classified as non-combustible according to EN ISO 1182. Europe: EN 13501-1, A2-s1,d0,

Humidity Resistance: According to EN 13964:2014 Standard: Class C, RH 95% and 30°C, Plant: Class A, RH 70% and 25°C,

Visual appearance: White Frost, nearest NCS colour sample S 0500-N, 85% light reflectance. Gloss < 1.

Cleanability: Daily dusting and vacuum cleaning. Weekly wet wiping.

Accessibility: The tiles in size 600x600 and 1200x600 are easily demountable. The tiles in size 1200x1200 and XL sizes are demountable. Minimum demounting depth according to installation diagrams.

Installation: Installed according to installation diagrams, installation guides and drawing aid. For information regarding minimum overall depth of system see quantity specification. The systems are not recommended for small rooms (approximately 2x2 m²). Ceilings with a large amount of integrations require careful planning, design and installation.

System weight: The weight of the system (including suspension grid) should be approximately 3-4 kg/m².

Mechanical properties: See table about Max live load and Min load bearing capacity and Functional demands, Mechanical properties at www.ecophon.com.

CE: Ecophon ceiling systems are CE marked according to the European harmonized standard EN 13964:2014. CE marked construction products are covered by a Declaration of Performance (DOP) which enables customers and users to easily compare performance of products available on the European market.

Installation diagram in detail www.ecophon.com

M206
Installation diagram (M206) for Ecophon Focus Ds 600x600, 1200x600 mm and Ecophon Focus Ds XL. Suspended installation

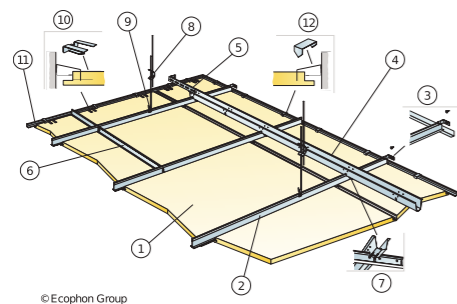

M206DIN
Installation diagram (M206DIN) for Ecophon Focus Ds 625x625, 1250x625 mm. Suspended installation

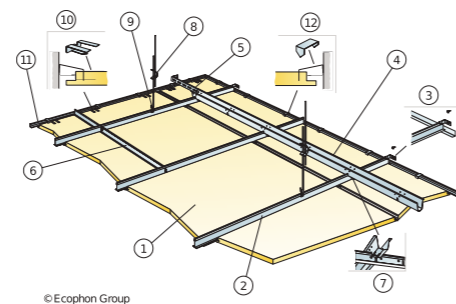

M207
Installation diagram (M207) for Ecophon Focus Ds 1200x1200 mm

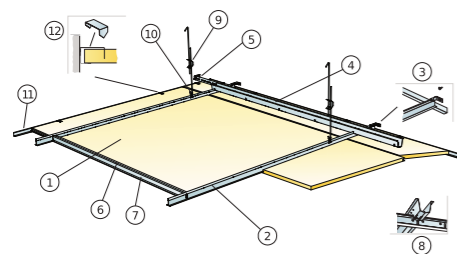

M208
Installation diagram (M208) for Ecophon Focus Ds, direct installation

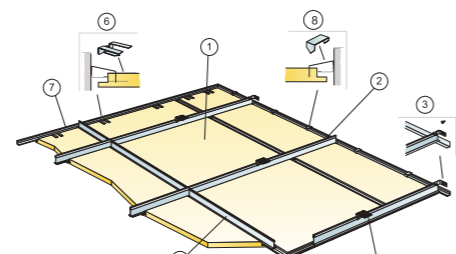

M238
Installation diagram (M238) for Ecophon Focus Ds XL in corridors

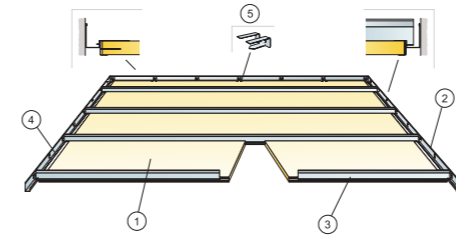

M394
Installation diagram (M394) for Ecophon Focus Ds Level change

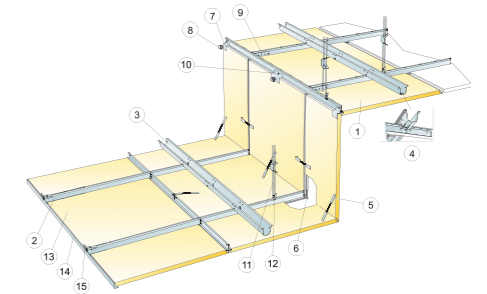

M400
Installation diagram (M400) for Ecophon Focus Ds

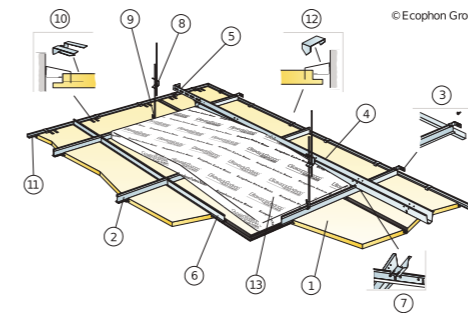

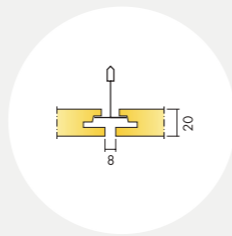

Ecophon Focus™ Dg

Acoustic

Sound Absorption:

Test results according to EN ISO 354. Classification according to EN ISO 11654, and the single value ratings for Noise Reduction Coefficient, NRC and Sound Absorption Average, SAA according to ASTM C 423.

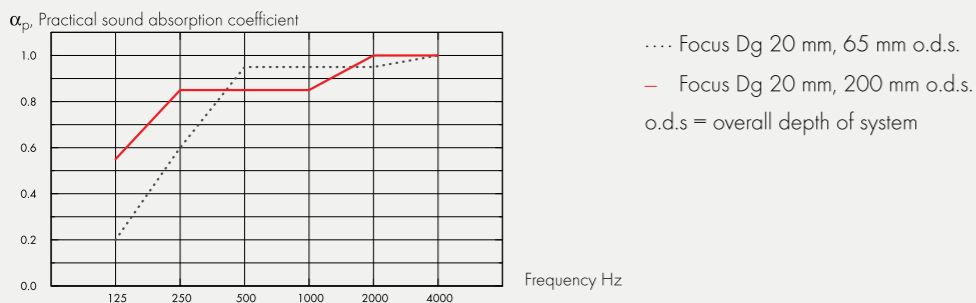

THK mm	o.d.s. mm	α_p , Practical sound absorption coefficient						α_w	Sound absorption class
		125 Hz	250 Hz	500 Hz	1000 Hz	2000 Hz	4000 Hz		
20	65	0.20	0.60	0.95	0.95	0.95	1.00	0.90	A
20	200	0.55	0.85	0.85	0.85	1.00	1.00	0.90	A

	THK mm	o.d.s. mm	NRC	SAA
-	20	65	0.90	0.89
-	20	400	0.80	0.82

THK mm	AC(1.5)
20	180

Articulation Class, ASTM E1111, ASTM E1110

Indoor Air Quality:

Certificate / Label	Standard	Plant
Eurofins Indoor Air Comfort®	IAC	IAC Gold
French VOC	A	A+
Finnish M1	•	•

Environmental Footprint: Focus Dg: 3,13 (Focus family EPD in conformity with ISO 14025 / EN 15804), Focus Dg/Plant: 2,76 (Focus Dg/Plant EPD in conformity with ISO 14025 / EN 15804),

Circularity: Minimum post-consumer recycled content: 52%, Recyclability: Fully recyclable,

Fire safety: The glass wool core of the tiles is tested and classified as non-combustible according to EN ISO 1182. Europe: EN 13501-1, A2-s1,d0,

Humidity Resistance: According to EN 13964:2014 Standard: Class C, RH 95% and 30°C, Plant: Class A, RH 70% and 25°C,

Visual appearance: White Frost, nearest NCS colour sample S 0500-N, 85% light reflectance. Gloss < 1.

Cleanability: Daily dusting and vacuum cleaning. Weekly wet wiping.

Accessibility: The tiles in size 600x600 and 1200x600 are easily demountable. The tiles in size 1200x1200 and XL sizes are demountable. Minimum demounting depth according to installation diagrams.

Installation: Installed according to installation diagrams, installation guides and drawing aid. For information regarding minimum overall depth of system see quantity specification. The systems are not recommended for small rooms (approximately 2x2 m²). Ceilings with a large amount of integrations require careful planning, design and installation.

System weight: The weight of the system (including suspension grid) should be approximately 3-4 kg/m².

Mechanical properties: See table about Max live load and Min load bearing capacity and Functional demands, Mechanical properties at www.ecophon.com.

CE: Ecophon ceiling systems are CE marked according to the European harmonized standard EN13964:2014. CE marked construction products are covered by a Declaration of Performance (DOP) which enables customers and users to easily compare performance of products available on the European market.

Installation diagram in detail www.ecophon.com

M202
Installation diagram (M202) for Ecophon Focus Dg 600x600, 1200x600 mm

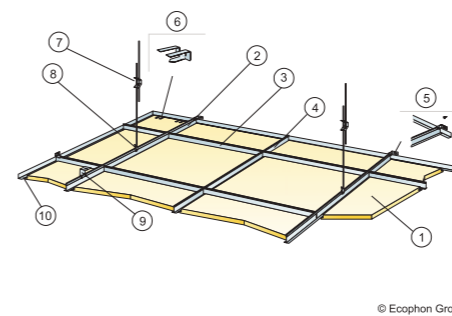

M202DIN
Installation diagram (M202DIN) for Ecophon Focus Dg 625x625, 1250x625 mm

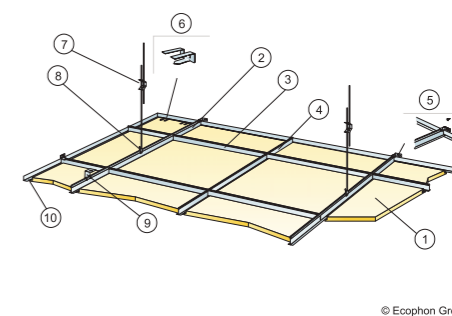

M203
Installation diagram (M203) for Ecophon Focus Dg 1200x1200 mm

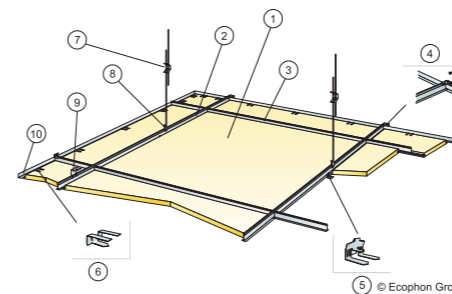

M204
Installation diagram (M204) for Ecophon Focus Dg XL

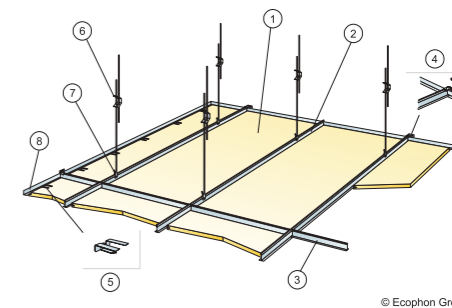

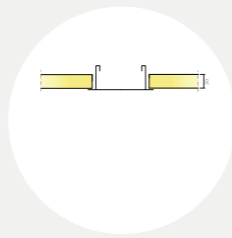

Ecophon Focus™ D/A

Acoustic

Sound Absorption:

Test results according to EN ISO 354. Classification according to EN ISO 11654, and the single value ratings for Noise Reduction Coefficient, NRC and Sound Absorption Average, SAA according to ASTM C 423.

α_p , Practical sound absorption coefficient

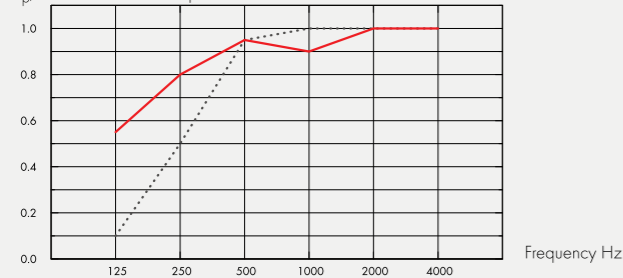

..... Focus D/A 20 mm, 60 mm o.d.s.
 — Focus D/A 20 mm, 200 mm o.d.s.
 o.d.s = overall depth of system

THK mm	o.d.s. mm	α_p , Practical sound absorption coefficient						α_w	Sound absorption class
		125 Hz	250 Hz	500 Hz	1000 Hz	2000 Hz	4000 Hz		
20	60	0.10	0.50	0.95	1.00	1.00	1.00	0.80	A
20	200	0.55	0.80	0.95	0.90	1.00	1.00	0.95	A

	THK mm	o.d.s. mm	NRC	SAA
-	20	60	0.90	0.89
-	20	400	0.80	0.82

THK mm	AC(1.5)		D_{nfw}	CAC dB
	Articulation Class, ASTM E1111, ASTM E1110			
20	180		24	25

Indoor Air Quality:

Certificate / Label	Standard	Plant
Eurofins Indoor Air Comfort®	IAC	IAC Gold
French VOC	A	A+
Finnish M1	•	•

Circularity: Fully recyclable.

Fire safety: The glass wool core of the tiles is tested and classified as non-combustible according to EN ISO 1182. Europe: EN 13501-1, A2-s1,d0,

Humidity Resistance: According to EN 13964:2014 Standard: Class C, RH 95% and 30°C, Plant: Class A, RH 70% and 25°C,

Visual appearance: White Frost, nearest NCS colour sample S 0500-N, 85% light reflectance. Gloss < 1.

Cleanability: Daily dusting and vacuum cleaning. Weekly wet wiping.

Accessibility: The tiles are easily demountable. Minimum demounting depth according to installation diagrams.

Installation: Installed according to installation diagram and bandraster/grid supplier recommendations.

System weight: The weight of the system (including suspension grid) should be approximately 2 kg/m².

Mechanical properties: See table about Max live load and Min load bearing capacity and Functional demands, Mechanical properties at www.ecophon.com.

CE: Ecophon ceiling systems are CE marked according to the European harmonized standard EN13964:2014. CE marked construction products are covered by a Declaration of Performance (DOP) which enables customers and users to easily compare performance of products available on the European market.

Installation diagram in detail www.ecophon.com

M17

Installation diagram (M17) for Focus D/A in corridor

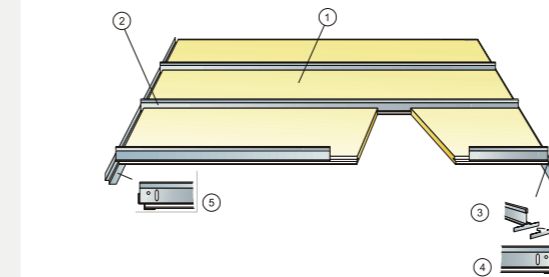

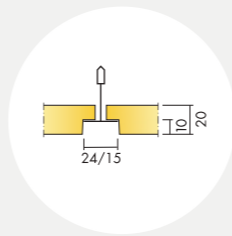

Ecophon Focus™ E

Acoustic

Sound Absorption:

Test results according to EN ISO 354. Classification according to EN ISO 11654, and the single value ratings for Noise Reduction Coefficient, NRC and Sound Absorption Average, SAA according to ASTM C 423.

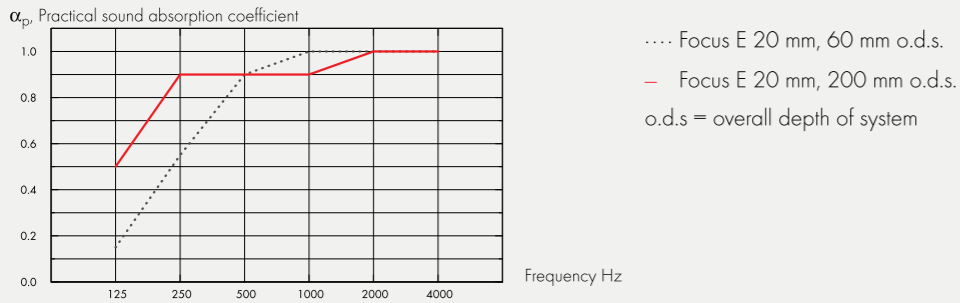

THK mm	o.d.s. mm	α_p Practical sound absorption coefficient						α_w	Sound absorption class
		125 Hz	250 Hz	500 Hz	1000 Hz	2000 Hz	4000 Hz		
20	60	0.15	0.55	0.90	1.00	1.00	1.00	0.85	B
20	200	0.50	0.90	0.90	0.90	1.00	1.00	0.95	A

THK mm	o.d.s. mm	NRC	SAA
-	20	0.90	0.87
-	20	0.85	0.85

THK mm	AC(1.5)		D_{nfw}		CAC dB	
	Articulation Class, ASTM E1111, ASTM E1110		Weighted normalized flanking level difference, ISO 10848-2		Ceiling Attenuation Class, ASTM 1414, ASTM E413	
20	180		22		23	

Indoor Air Quality:

Certificate / Label	Standard	Plant
Eurofins Indoor Air Comfort®	IAC	IAC Gold
French VOC	A	A+
Finnish M1	•	•

Environmental Footprint: Focus E: 3,13 (Focus family EPD in conformity with ISO 14025 / EN 15804), Focus E/Plant: 2,35 (Focus E/Plant EPD in conformity with ISO 14025 / EN 15804),

Circularity: Minimum post-consumer recycled content: 52%, Recyclability: Fully recyclable,

Fire safety: The glass wool core of the tiles is tested and classified as non-combustible according to EN ISO 1182. Europe: EN 13501-1, A2-s1,d0,

Humidity Resistance: According to EN 13964:2014 Standard: Class C, RH 95% and 30°C, Plant: Class A, RH 70% and 25°C,

Visual appearance: White Frost, nearest NCS colour sample S 0500-N, 85% light reflectance. Gloss < 1.

Cleanability: Daily dusting and vacuum cleaning. Weekly wet wiping.

Accessibility: The tiles are easily demountable. Minimum demounting depth according to installation diagrams.

Installation: Installed according to installation diagrams, installation guides and drawing aid. For information regarding minimum overall depth of system see quantity specification.

System weight: The weight of the system (including suspension grid) should be approximately 3 kg/m².

Mechanical properties: See table about Max live load and Min load bearing capacity and Functional demands, Mechanical properties at www.ecophon.com.

CE: Ecophon ceiling systems are CE marked according to the European harmonized standard EN13964:2014. CE marked construction products are covered by a Declaration of Performance (DOP) which enables customers and users to easily compare performance of products available on the European market.

Installation diagram in detail www.ecophon.com

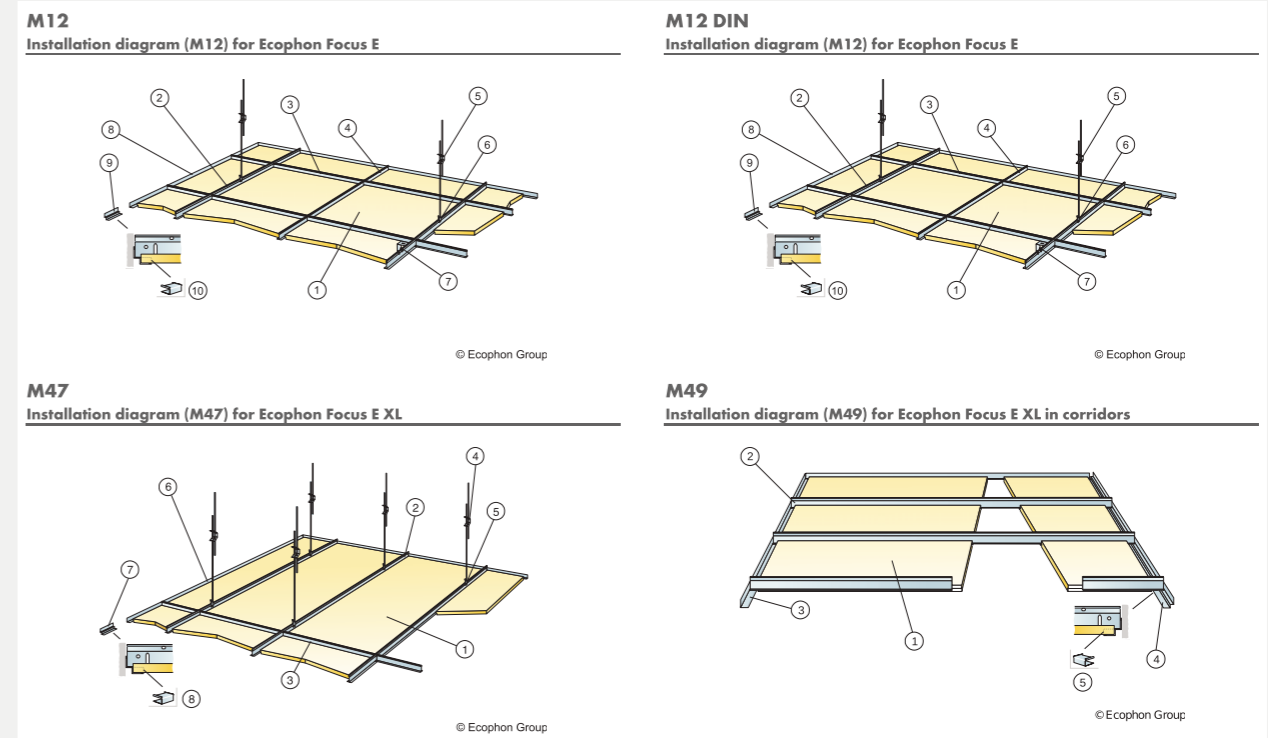

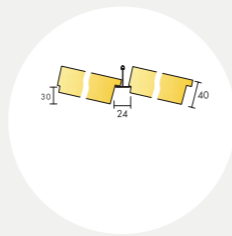

Ecophon Focus™ Ez

Acoustic

Sound Absorption:

Test results according to EN ISO 354. Classification according to EN ISO 11654, and the single value ratings for Noise Reduction Coefficient, NRC and Sound Absorption Average, SAA according to ASTM C 423.

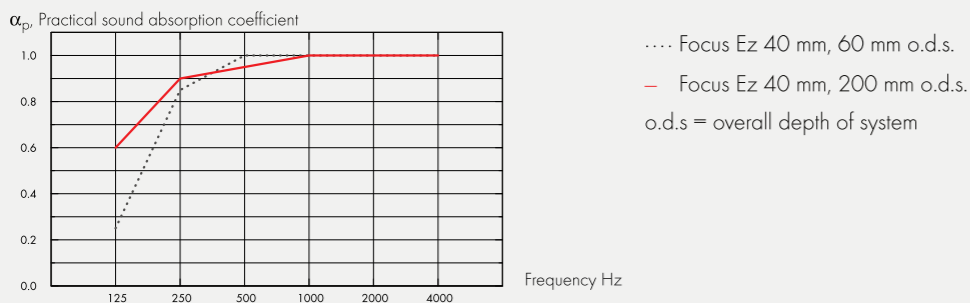

..... Focus Ez 40 mm, 60 mm o.d.s.
 — Focus Ez 40 mm, 200 mm o.d.s.
 o.d.s = overall depth of system

THK mm	o.d.s. mm	α_p Practical sound absorption coefficient						α_w	Sound absorption class
		125 Hz	250 Hz	500 Hz	1000 Hz	2000 Hz	4000 Hz		
40	60	0.25	0.85	1.00	1.00	1.00	1.00	1.00	A
40	200	0.60	0.90	0.95	1.00	1.00	1.00	1.00	A

	THK mm	o.d.s. mm	NRC	SAA
-	40	60	1.00	0.99
-	40	200	1.00	0.97

THK mm	AC(1.5) Articulation Class, ASTM E1111, ASTM E1110	D_{nfw} Weighted normalized flanking level difference, ISO 10848-2	CAC dB Ceiling Attenuation Class, ASTM 1414, ASTM E413
40	200	29	31

Indoor Air Quality:

Certificate / Label	Standard	Plant
Eurofins Indoor Air Comfort®	IAC	IAC Gold
French VOC	A	A+
Finnish M1	•	•

Circularity: Minimum post-consumer recycled content: 52%, Recyclability: Fully recyclable,

Fire safety: The glass wool core of the tiles is tested and classified as non-combustible according to EN ISO 1182. Europe: EN 13501-1, A2-s1,d0,

Humidity Resistance: According to EN 13964:2014 Standard: Class C, RH 95% and 30°C, Plant: Class A, RH 70% and 25°C,

Visual appearance: White Frost, nearest NCS colour sample S 0500-N, 85% light reflectance. Gloss < 1.

Cleanability: Daily dusting and vacuum cleaning. Weekly wet wiping.

Accessibility: The tiles are easily demountable. Minimum demounting depth according to installation diagrams.

Installation: Installed according to installation diagrams, installation guides and drawing aid. For information regarding minimum overall depth of system see quantity specification.

System weight: The weight of the system (including suspension grid) should be approximately 5 kg/m²

Mechanical properties: See table about Max live load and Min load bearing capacity and Functional demands, Mechanical properties at www.ecophon.com.

CE: Ecophon ceiling systems are CE marked according to the European harmonized standard EN13964:2014. CE marked construction products are covered by a Declaration of Performance (DOP) which enables customers and users to easily compare performance of products available on the European market.

Installation diagram in detail www.ecophon.com

M393

Installation diagram (M393) for Ecophon Focus Ez

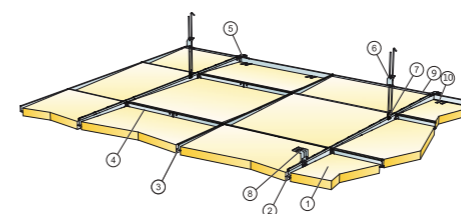

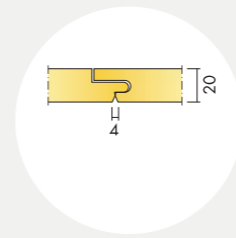

Ecophon Focus™ F

Acoustic

Sound Absorption:

Test results according to EN ISO 354. Classification according to EN ISO 11654, and the single value ratings for Noise Reduction Coefficient, NRC and Sound Absorption Average, SAA according to ASTM C 423.

α_p , Practical sound absorption coefficient

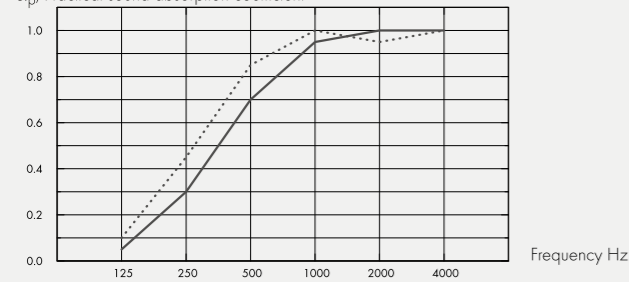

— Focus F 20 mm, 20 mm o.d.s.
 Focus F 20 mm, 40 mm o.d.s.
 o.d.s = overall depth of system

THK mm	o.d.s. mm	α_p , Practical sound absorption coefficient						α_w	Sound absorption class
		125 Hz	250 Hz	500 Hz	1000 Hz	2000 Hz	4000 Hz		
20	20	0.05	0.30	0.70	0.95	1.00	1.00	0.60	C
20	40	0.10	0.45	0.85	1.00	0.95	1.00	0.75	C

THK mm	o.d.s. mm	NRC	SAA
20	20	0.75	0.77

Indoor Air Quality:

Certificate / Label	Standard	Plant
Eurofins Indoor Air Comfort®	IAC	IAC Gold
French VOC	A	A+
Finnish M1	•	•

Environmental Footprint: Focus F: 3,13 (Focus family EPD in conformity with ISO 14025 / EN 15804), Focus F/Plant: 2,76 (Focus F/Plant EPD in conformity with ISO 14025 / EN 15804),

Circularity: Minimum post-consumer recycled content: 52%, Recyclability: Fully recyclable,

Fire safety: The glass wool core of the tiles is tested and classified as non-combustible according to EN ISO 1182. Europe: EN 13501-1, A2-s1,d0,

Humidity Resistance: According to EN 13964:2014 Standard: Class C, RH 95% and 30°C, Plant: Class A, RH 70% and 25°C,

Visual appearance: White Frost, nearest NCS colour sample S 0500-N, 85% light reflectance. Gloss < 1.

Cleanability: Daily dusting and vacuum cleaning. Weekly wet wiping.

Accessibility: The tiles are not demountable.

Installation: Installed according to installation diagrams, installation guides and drawing aid. For information regarding minimum overall depth of system see quantity specification. For best result the surface should be even, however an acceptable result could be achieved on slightly uneven surfaces. If very uneven surfaces - installation of furring (evenly spaced timber battens) as the substrate for the tiles is recommended.

System weight: The weight of the system should be approximately 2,5 kg/m²

Mechanical properties: Additional live load has to be fixed to the soffit.

CE: Ecophon ceiling systems are CE marked according to the European harmonized standard EN13964:2014. CE marked construction products are covered by a Declaration of Performance (DOP) which enables customers and users to easily compare performance of products available on the European market.

Installation diagram in detail www.ecophon.com

M15

Installation diagram (M15) for Ecophon Focus F

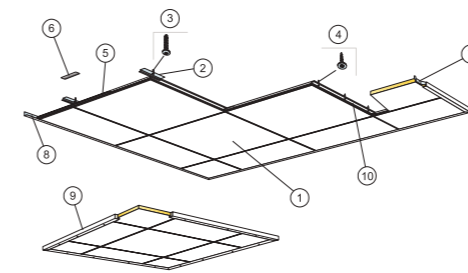

© Ecophon Group

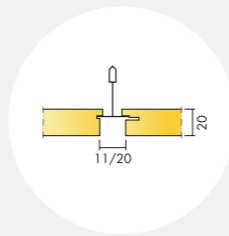

Ecophon Focus™ Lp

Acoustic

Sound Absorption:

Test results according to EN ISO 354. Classification according to EN ISO 11654, and the single value ratings for Noise Reduction Coefficient, NRC and Sound Absorption Average, SAA according to ASTM C 423.

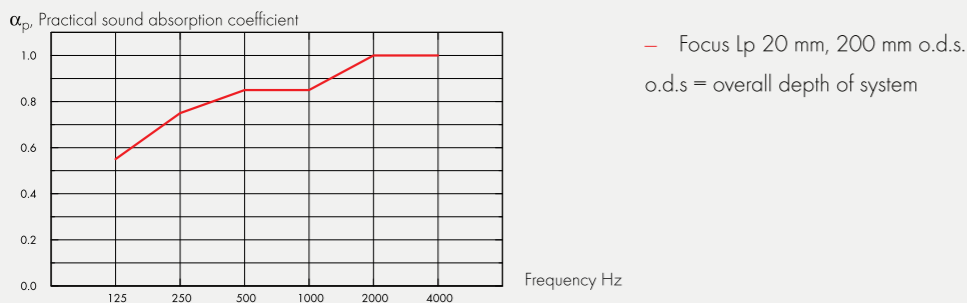

THK mm	o.d.s. mm	α_p Practical sound absorption coefficient						α_w	Sound absorption class
		125 Hz	250 Hz	500 Hz	1000 Hz	2000 Hz	4000 Hz		
20	200	0.55	0.75	0.85	0.85	1.00	1.00	0.90	A

THK mm	o.d.s. mm	NRC	SAA
-	20	0.80	0.82

THK mm	AC(1.5) Articulation Class, ASTM E1111, ASTM E1110	D_{nfw} Weighted normalized flanking level difference, ISO 10848-2	CAC dB Ceiling Attenuation Class, ASTM 1414, ASTM E413
20	180	24	25

Indoor Air Quality:

Certificate / Label	Standard	Plant
Eurofins Indoor Air Comfort®	IAC	IAC Gold
French VOC	A	A+
Finnish M1	•	•

Environmental Footprint: Focus Lp: 3,13 (Focus family EPD in conformity with ISO 14025 / EN 15804), Focus Lp/Plant: 2,76 (Focus Lp/Plant EPD in conformity with ISO 14025 / EN 15804),

Circularity: Minimum post-consumer recycled content: 52%, Recyclability: Fully recyclable,

Fire safety: The glass wool core of the tiles is tested and classified as non-combustible according to EN ISO 1182. Europe: EN 13501-1, A2-s1,d0,

Humidity Resistance: According to EN 13964:2014 Standard: Class C, RH 95% and 30°C, Plant: Class A, RH 70% and 25°C,

Visual appearance: White Frost, nearest NCS colour sample S 0500-N, 85% light reflectance. Gloss < 1.

Cleanability: Daily dusting and vacuum cleaning. Weekly wet wiping.

Accessibility: The tiles are easily demountable. Minimum demounting depth according to installation diagrams.

Installation: Installed according to installation diagrams, installation guides and drawing aid. For information regarding minimum overall depth of system see quantity specification. The systems are not recommended for small rooms (approximately 2x2 m2). Ceilings with a large amount of integrations require careful planning, design and installation.

System weight: The weight of the system (including suspension grid) should be approximately 3-4 kg/m².

Mechanical properties: See table about Max live load and Min load bearing capacity and Functional demands, Mechanical properties at www.ecophon.com. For the Technical tiles installed according to M391 there is a load bearing capacity of 100 N for each Main runner per 1200 mm. This gives a total load bearing capacity of 200 N for a load evenly distributed on two Main runners.

CE: Ecophon ceiling systems are CE marked according to the European harmonized standard EN 13964:2014. CE marked construction products are covered by a Declaration of Performance (DOP) which enables customers and users to easily compare performance of products available on the European market.

Installation diagram in detail www.ecophon.com

M390

Installation diagram (M278) for Ecophon Focus Lp

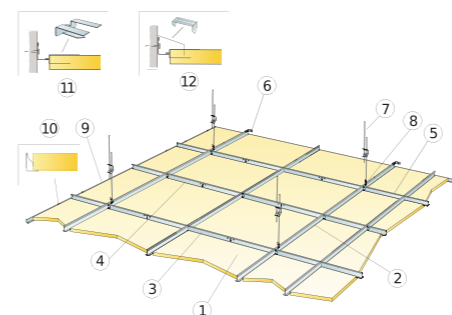

M391

Installation diagram (M279) for Ecophon Focus Lp Technical tile

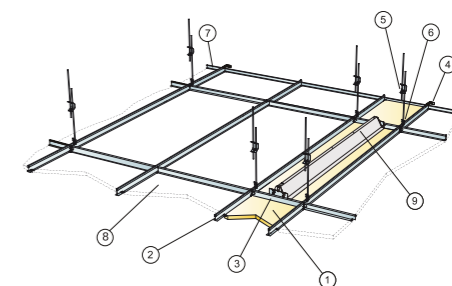

M392

Installation diagram (M278) for Ecophon Focus Lp XL

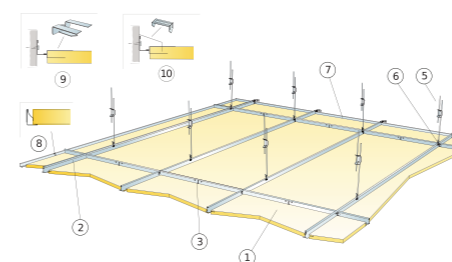

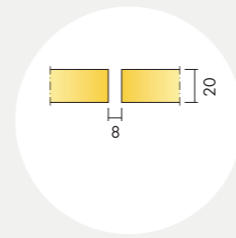

Ecophon Focus™ SQ

Acoustic

Sound Absorption:

Test results according to EN ISO 354. Classification according to EN ISO 11654, and the single value ratings for Noise Reduction Coefficient, NRC and Sound Absorption Average, SAA according to ASTM C 423.

α_p , Practical sound absorption coefficient

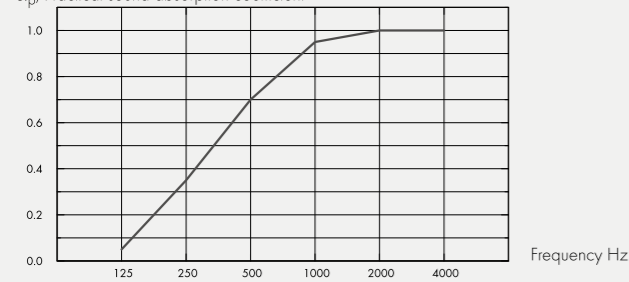

— Focus SQ 20 mm, 20 mm o.d.s.
o.d.s = overall depth of system

THK mm	o.d.s. mm	α_p , Practical sound absorption coefficient						α_w	Sound absorption class
		125 Hz	250 Hz	500 Hz	1000 Hz	2000 Hz	4000 Hz		
20	20	0.05	0.35	0.70	0.95	1.00	1.00	0.65	C

THK mm	AC(1.5)
20	Articulation Class, ASTM E1111, ASTM E1110 190

Indoor Air Quality:

Certificate / Label	Standard	Plant
Eurofins Indoor Air Comfort®	IAC	IAC Gold
French VOC	A	A+
Finnish M1	•	•

Environmental Footprint: Focus Lp: 3,13 (Focus family EPD in conformity with ISO 14025 / EN 15804), Focus Lp/Plant: 2,76 (Focus Lp/Plant EPD in conformity with ISO 14025 / EN 15804),

Circularity: Minimum post-consumer recycled content: 52%, Recyclability: Fully recyclable,

Fire safety: The glass wool core of the tiles is tested and classified as non-combustible according to EN ISO 1182. Europe: EN 13501-1, A2-s1,d0,

Humidity Resistance: According to EN 13964:2014 Standard: Class C, RH 95% and 30°C, Plant: Class A, RH 70% and 25°C,

Visual appearance: White Frost, nearest NCS colour sample S 0500-N, 85% light reflectance. Gloss < 1.

Cleanability: Daily dusting and vacuum cleaning. Weekly wet wiping.

Accessibility: The tiles are not demountable.

Installation: Installed according to installation diagrams, installation guides and drawing aid. For information regarding minimum overall depth of system see quantity specification. Rendered surfaces must have sufficient strength to be able to carry the load imposed by the tiles. If doubts, test gluing should be carried out. The surface should always be dry and clean. For best result the surface should be even, however an acceptable result could be achieved on slightly uneven surfaces.

System weight: The weight of the system should be approximately 2,5 kg/m²

Mechanical properties: Additional live load has to be fixed to the soffit.

CE: Ecophon ceiling systems are CE marked according to the European harmonized standard EN13964:2014. CE marked construction products are covered by a Declaration of Performance (DOP) which enables customers and users to easily compare performance of products available on the European market.

Installation diagram in detail www.ecophon.com

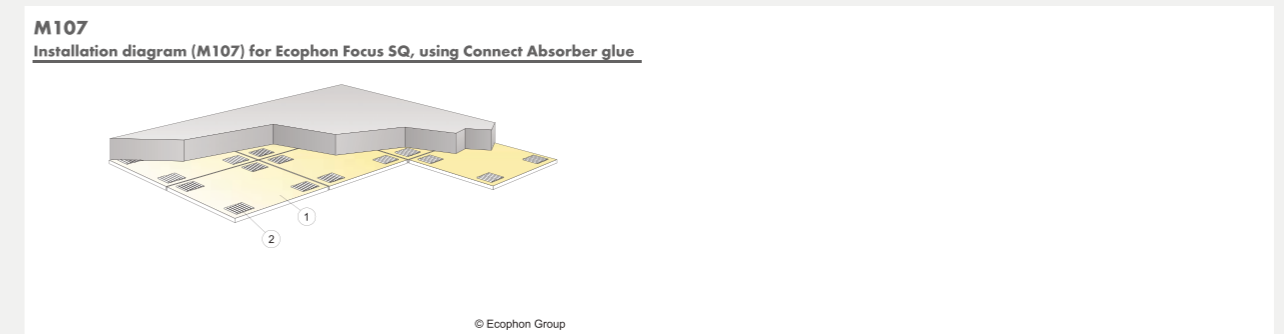

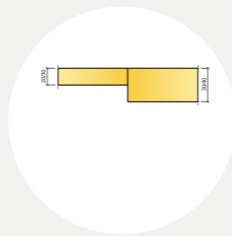

Ecophon Focus™ Levels

Acoustic

Sound Absorption:

Test results according to EN ISO 354. Classification according to EN ISO 11654, and the single value ratings for Noise Reduction Coefficient, NRC and Sound Absorption Average, SAA according to ASTM C 423.

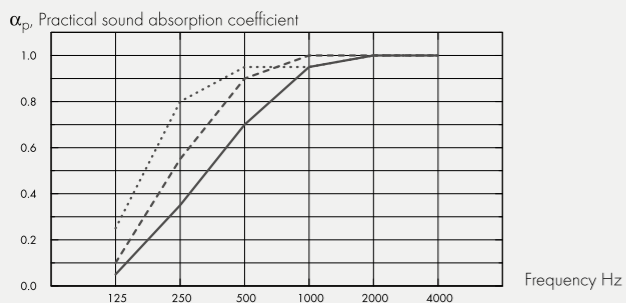

.... Focus Levels 40 mm, 43 mm o.d.s.
 --- Focus Levels 30 mm, 33 mm o.d.s.
 — Focus Levels 20 mm, 23 mm o.d.s.
 o.d.s = overall depth of system



— Focus Levels 20/30/40 mm (M488, M489), 23-43 mm o.d.s.
 o.d.s = overall depth of system

THK mm	o.d.s. mm	α_p Practical sound absorption coefficient						α_w	Sound absorption class
		125 Hz	250 Hz	500 Hz	1000 Hz	2000 Hz	4000 Hz		
40	43	0.25	0.80	0.95	0.95	1.00	1.00	A	
30	33	0.10	0.55	0.90	1.00	1.00	1.00	B	
20	23	0.05	0.35	0.70	0.95	1.00	1.00	C	
0	43	0.15	0.55	0.90	0.95	1.00	1.00	B	

Indoor Air Quality:

Certificate / Label	
Eurofins Indoor Air Comfort®	IAC
French VOC	A
Finnish M1	•

Circularity: Fully recyclable.

Fire safety: The glass wool core of the tiles is tested and classified as non-combustible according to EN ISO 1182. Europe: EN 13501-1, A2-s1,d0,

Humidity Resistance: Class C, relative humidity 95% and 30°C, according to EN 13964:2014

Visual appearance: White Frost, nearest NCS colour sample S 0500-N, 85% light reflectance. Gloss < 1.

Cleanability: Daily dusting and vacuum cleaning. Weekly wet wiping.

Accessibility: The tiles are not demountable.

Installation: Installed according to installation diagrams, installation guides and drawing aid. For information regarding minimum overall depth of system see quantity specification. Rendered surfaces must have sufficient strength to be able to carry the load imposed by the tiles. If doubts, test gluing should be carried out. The surface should always be dry and clean. For best result the surface should be even, however an acceptable result could be achieved on slightly uneven surfaces.

Mechanical properties: Additional live load has to be fixed to the soffit.

CE: Ecophon ceiling systems are CE marked according to the European harmonized standard EN 13964:2014. CE marked construction products are covered by a Declaration of Performance (DOP) which enables customers and users to easily compare performance of products available on the European market.

Installation diagram in detail www.ecophon.com

M488
 Installation diagram (M488) for Ecophon Focus Levels, using Connect Absorber glue

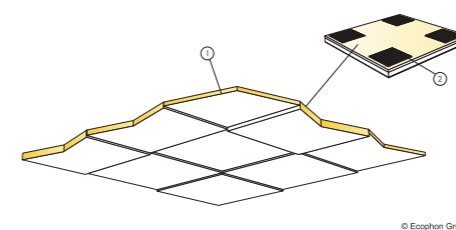

M489
 Installation diagram (M489) for Ecophon Focus Levels, using Connect Absorber glue

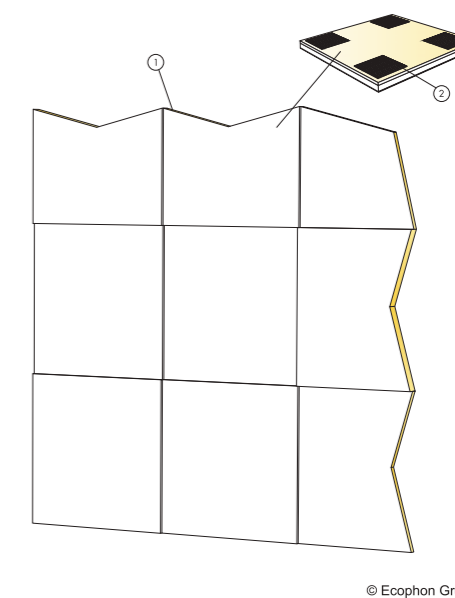

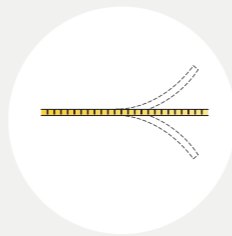

Ecophon Focus™ Flexiform A

Acoustic

Acoustic values corresponding to a flat ceiling.

Sound Absorption:

Test results according to EN ISO 354. Classification according to EN ISO 11654, and the single value ratings for Noise Reduction Coefficient, NRC and Sound Absorption Average, SAA according to ASTM C 423.

α_p , Practical sound absorption coefficient

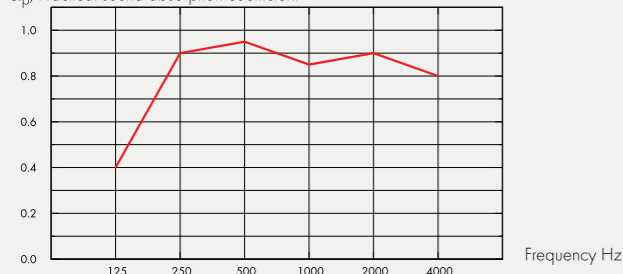

— Focus Flexiform A 30 mm, 200 mm o.d.s.
o.d.s = overall depth of system

THK mm	o.d.s. mm	α_p , Practical sound absorption coefficient						α_w	Sound absorption class
		125 Hz	250 Hz	500 Hz	1000 Hz	2000 Hz	4000 Hz		
30	200	0.40	0.90	0.95	0.85	0.90	0.80	0.90	A

THK mm	D_{nfw}		CAC dB
	Weighted normalized flanking level difference, ISO 10848-2		
20	24		25

Indoor Air Quality:

Certificate / Label	
Eurofins Indoor Air Comfort®	IAC
French VOC	A
Finnish M1	•

Circularity: Fully recyclable.

Fire safety: The glass wool core of the tiles is tested and classified as non-combustible according to EN ISO 1182. Europe: EN 13501-1, A2-s1,d0,

Humidity Resistance: Class C, relative humidity 95% and 30°C, according to EN 13964:2014

Visual appearance: White Frost, nearest NCS colour sample S 0500-N, 85% light reflectance. Gloss < 1.

Cleanability: Daily dusting and vacuum cleaning. Weekly wet wiping.

Accessibility: The tiles are not demountable.

Installation: Installed according to installation diagrams, installation guides and drawing aid. (Please note: Extreme incident light, near windows or other light sources, can create undesired shadow effects on the structured surface on curved installations.)

System weight: The weight is approximately 3 kg/m², depending on the installation method.

Mechanical properties: Additional live load has to be fixed to the soffit.

CE: Ecophon ceiling systems are CE marked according to the European harmonized standard EN13964:2014. CE marked construction products are covered by a Declaration of Performance (DOP) which enables customers and users to easily compare performance of products available on the European market.

Installation diagram in detail www.ecophon.com

M31

Installation diagram (M31) for Ecophon Focus Flexiform A

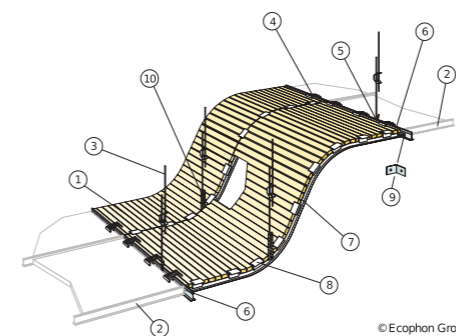

M31ec

Installation diagram (M31EC) for Ecophon Focus Flexiform A external corner

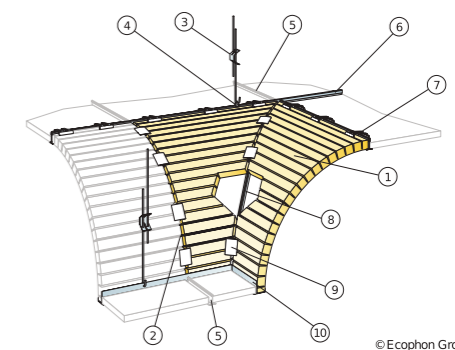

M31ic

Installation diagram (M31IC) for Ecophon Focus Flexiform A internal corner

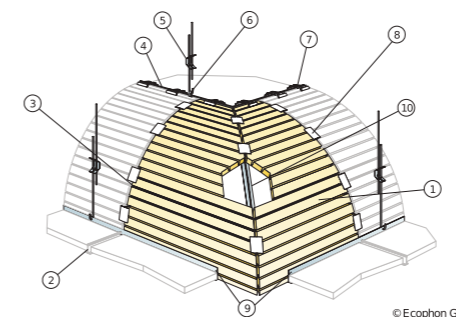

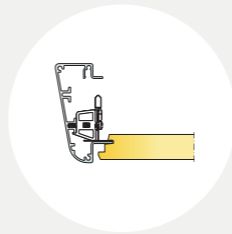

Ecophon Focus Edge™ 500

Acoustic: Ecophon Focus Edge 500 is a perimeter component. For acoustic data on the system - please see corresponding ceiling system (Focus Ds, Focus Dg or Focus/Master E).

Circularity: Fully recyclable.

Fire safety: Europe: EN 13501-1, A1,

Installation: Installed according to installation diagrams, installation guides and drawing aid. For information regarding minimum overall depth of system see quantity specification.

Mechanical properties: Additional live load has to be fixed to the soffit.

CE: Ecophon ceiling systems are CE marked according to the European harmonized standard EN13964:2014. CE marked construction products are covered by a Declaration of Performance (DOP) which enables customers and users to easily compare performance of products available on the European market.

Installation diagram in detail www.ecophon.com

M165
Installation diagram (M165) for Ecophon Edge 500 with Focus E T24

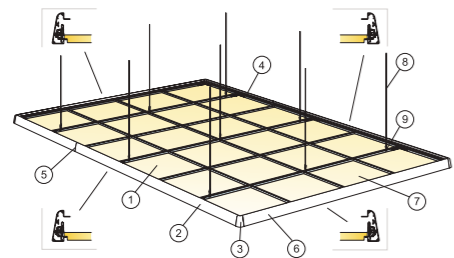

© Ecophon Group

M210
Installation diagram (M210) for Ecophon Edge 500 with Focus Ds

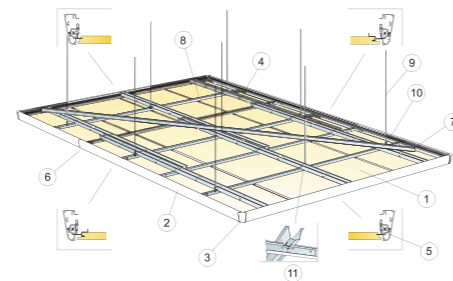

M211
Installation diagram (M211) for Ecophon Edge 500 with Focus Dg

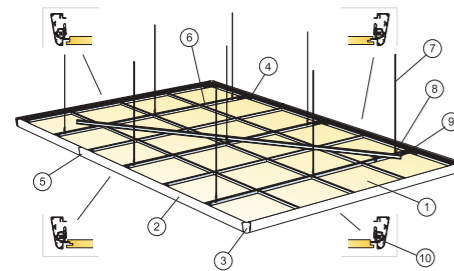

© Ecophon Group



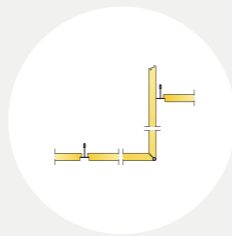

Ecophon Focus™ Fixiform E

Acoustic

Acoustic values corresponding to a flat ceiling.

Sound Absorption:

Test results according to EN ISO 354. Classification according to EN ISO 11654, and the single value ratings for Noise Reduction Coefficient, NRC and Sound Absorption Average, SAA according to ASTM C 423.

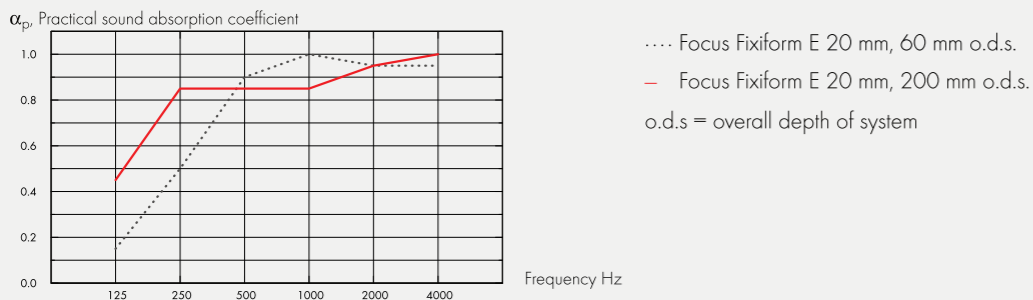

THK mm	o.d.s. mm	α_p Practical sound absorption coefficient						α_w	Sound absorption class
		125 Hz	250 Hz	500 Hz	1000 Hz	2000 Hz	4000 Hz		
20	60	0.15	0.50	0.90	1.00	0.95	0.95	0.80	B
20	200	0.45	0.85	0.85	0.85	0.95	1.00	0.90	A

THK mm	D_{nfw}	CAC dB
	Weighted normalized flanking level difference, ISO 10848-2	Ceiling Attenuation Class, ASTM 1414, ASTM E413
20	24	25

Indoor Air Quality:

Certificate / Label	
Eurofins Indoor Air Comfort®	IAC
French VOC	A
Finnish M1	•

Circularity: Fully recyclable.

Fire safety: The glass wool core of the tiles is tested and classified as non-combustible according to EN ISO 1182. Europe: EN 13501-1, A2-s1,d0,

Humidity Resistance: Class C, relative humidity 95% and 30°C, according to EN 13964:2014

Visual appearance: White Frost, nearest NCS colour sample S 0500-N, 85% light reflectance. Gloss < 1.

Cleanability: Daily dusting and vacuum cleaning. Weekly wet wiping.

Accessibility: The panels are demountable via adjacent flat ceiling tiles.

Installation: Installed according to installation diagrams, installation guides and drawing aid. Focus Fixiform E is supplied with all necessary installation accessories.

Mechanical properties: Additional live load has to be fixed to the soffit.

CE: Ecophon ceiling systems are CE marked according to the European harmonized standard EN13964:2014. CE marked construction products are covered by a Declaration of Performance (DOP) which enables customers and users to easily compare performance of products available on the European market.

Installation diagram in detail www.ecophon.com

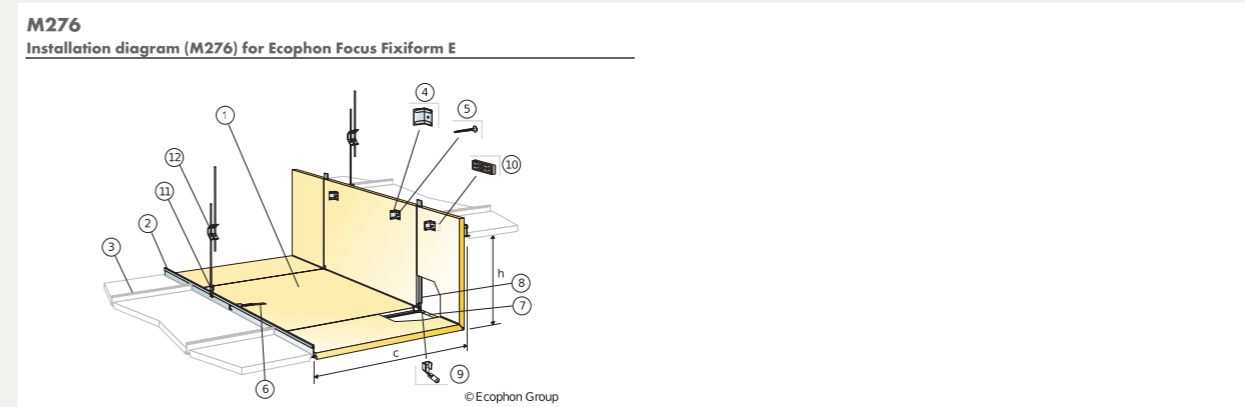

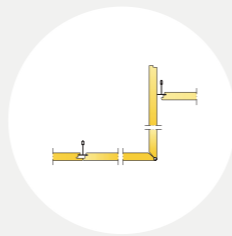

Ecophon Focus™ Fixiform Ds

Acoustic

Acoustic values corresponding to a flat ceiling.

Sound Absorption:

Test results according to EN ISO 354. Classification according to EN ISO 11654.

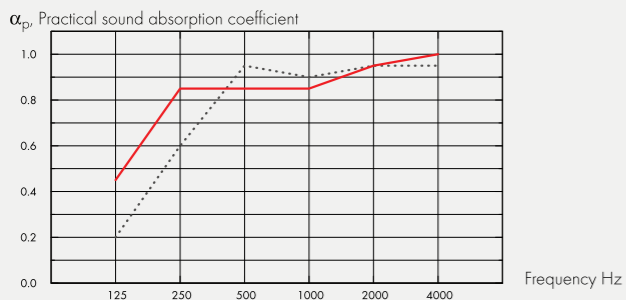

..... Focus Fixiform Ds 20 mm, 75 mm o.d.s.
 — Focus Fixiform Ds 20 mm, 200 mm o.d.s.
 o.d.s = overall depth of system

THK mm	o.d.s. mm	α_p , Practical sound absorption coefficient						α_w	Sound absorption class
		125 Hz	250 Hz	500 Hz	1000 Hz	2000 Hz	4000 Hz		
20	75	0.20	0.60	0.95	0.90	0.95	0.95	0.90	A
20	200	0.45	0.85	0.85	0.85	0.95	1.00	0.90	A

THK mm	D_{nfw}		CAC dB	
	Weighted normalized flanking level difference, ISO 10848-2		Ceiling Attenuation Class, ASTM 1414, ASTM E413	
20	24		25	

Indoor Air Quality:

Certificate / Label	
Eurofins Indoor Air Comfort®	IAC
French VOC	A
Finnish M1	•

Circularity: Fully recyclable.

Fire safety: The glass wool core of the tiles is tested and classified as non-combustible according to EN ISO 1182. Europe: EN 13501-1, A2-s1,d0,

Humidity Resistance: Class C, relative humidity 95% and 30°C, according to EN 13964:2014

Visual appearance: White Frost, nearest NCS colour sample S 0500-N, 85% light reflectance. Gloss < 1.

Cleanability: Daily dusting and vacuum cleaning. Weekly wet wiping.

Accessibility: The panels are demountable via adjacent flat ceiling tiles.

Installation: Installed according to installation diagrams, installation guides and drawing aid. Focus Fixiform Ds is supplied with all necessary installation accessories.

Mechanical properties: Additional live load has to be fixed to the soffit.

CE: Ecophon ceiling systems are CE marked according to the European harmonized standard EN13964:2014. CE marked construction products are covered by a Declaration of Performance (DOP) which enables customers and users to easily compare performance of products available on the European market.

Installation diagram in detail www.ecophon.com

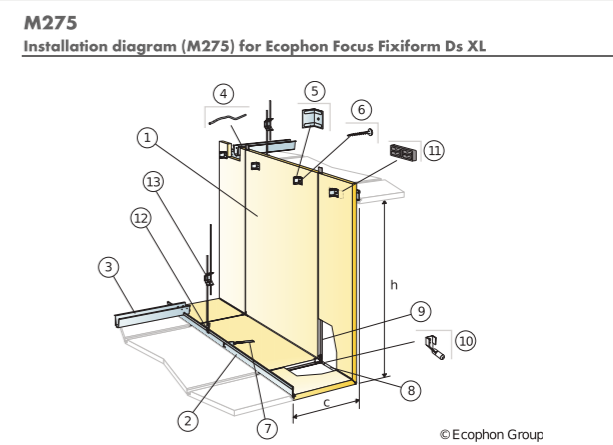
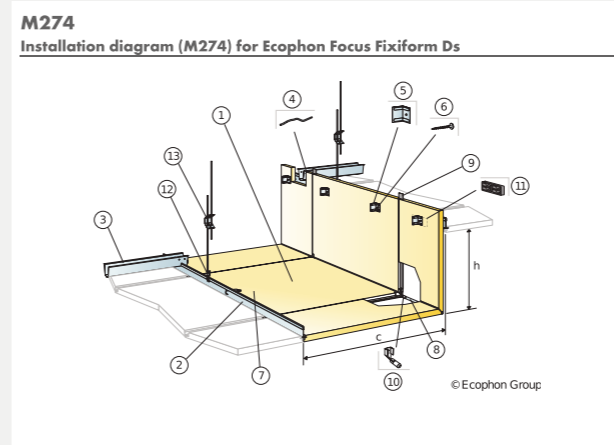

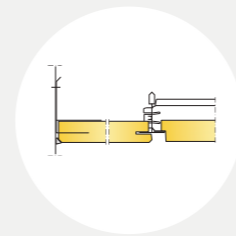

Ecophon Focus™ Frieze

Acoustic

Sound Absorption:

Test results according to EN ISO 354. Classification according to EN ISO 11654, and the single value ratings for Noise Reduction Coefficient, NRC and Sound Absorption Average, SAA according to ASTM C 423.

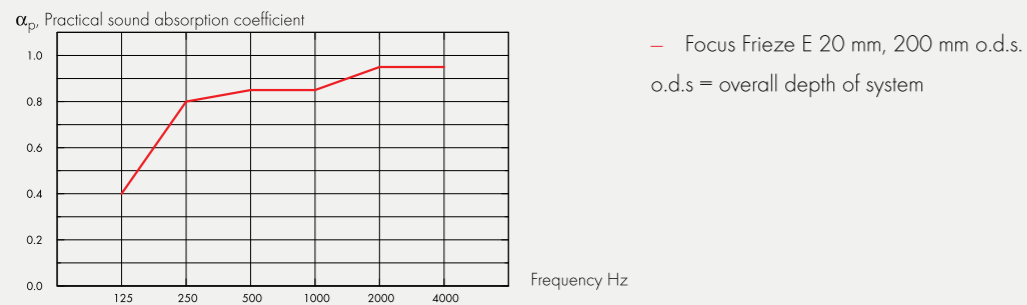

THK mm	o.d.s. mm	α_p Practical sound absorption coefficient						α_w	Sound absorption class
		125 Hz	250 Hz	500 Hz	1000 Hz	2000 Hz	4000 Hz		
20	200	0.40	0.80	0.85	0.85	0.95	0.95	0.90	A

THK mm	AC(1.5) Articulation Class, ASTM E1111, ASTM E1110	D_{nfw} Weighted normalized flanking level difference, ISO 10848-2	CAC dB Ceiling Attenuation Class, ASTM 1414, ASTM E413
20	190	24	25

Indoor Air Quality:

Certificate / Label	
Eurofins Indoor Air Comfort®	IAC
French VOC	A
Finnish M1	•

Circularity: Fully recyclable.

Fire safety: The glass wool core of the tiles is tested and classified as non-combustible according to EN ISO 1182. Europe: EN 13501-1, A2-s1,d0,

Humidity Resistance: Class C, relative humidity 95% and 30°C, according to EN 13964:2014

Visual appearance: White Frost, nearest NCS colour sample S 0500-N, 85% light reflectance. Gloss < 1.

Cleanability: Daily dusting and vacuum cleaning. Weekly wet wiping.

Accessibility: The tiles are not demountable.

Installation: Installed according to installation diagrams, installation guides and drawing aid. For information regarding minimum overall depth of system see quantity specification.

System weight: The system consists of Ecophon Focus™ frieze tiles and Connect™ grid systems, with an approximate weight of 3 kg/m².

Mechanical properties: See table about Max live load and Min load bearing capacity and Functional demands, Mechanical properties at www.ecophon.com.

CE: Ecophon ceiling systems are CE marked according to the European harmonized standard EN 13964:2014. CE marked construction products are covered by a Declaration of Performance (DOP) which enables customers and users to easily compare performance of products available on the European market.

Installation diagram in detail www.ecophon.com

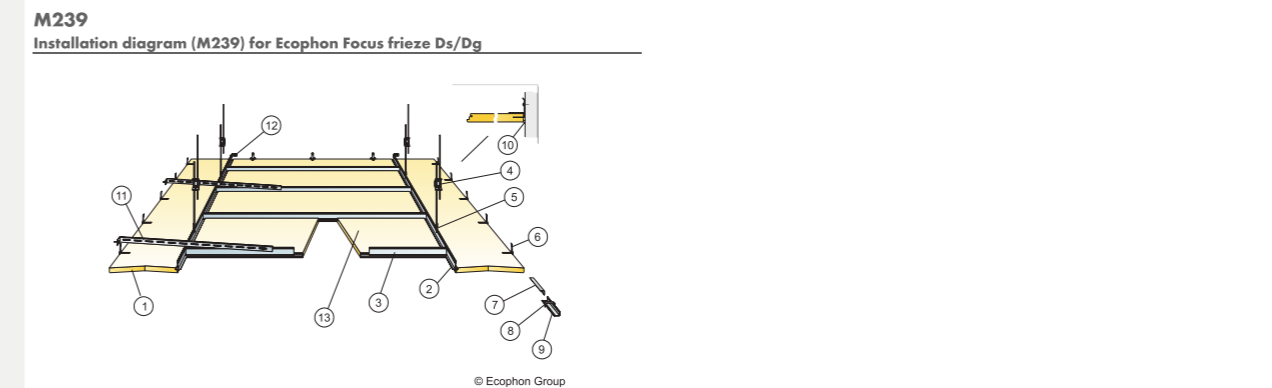

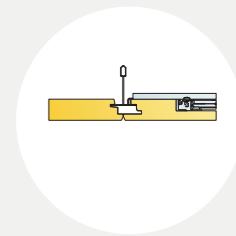
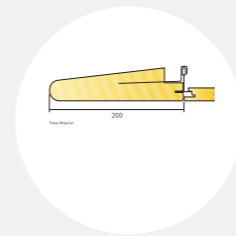

Ecophon Focus™ Wing

Acoustic: Ecophon Focus Wing is a perimeter component. As such it is absorbent, however, for acoustic data on the system - please see corresponding ceiling system (Focus Ds or Focus/Master E).

Indoor Air Quality:

Certificate / Label	
Eurofins Indoor Air Comfort®	IAC Gold
French VOC	A+

Circularity: Fully recyclable.

Fire safety: The glass wool core of the tiles is tested and classified as non-combustible according to EN ISO 1182. Europe: EN 13501-1, A2-s1,d0,

Humidity Resistance: Class C, relative humidity 95% and 30°C, according to EN 13964:2014

Visual appearance: White Frost, nearest NCS colour sample S 0500-N, 85% light reflectance. Gloss < 1.

Cleanability: Daily dusting and vacuum cleaning. Weekly wet wiping.

Accessibility: The tiles are not demountable.

Installation: Installed according to installation diagrams, installation guides and drawing aid. For information regarding minimum overall depth of system see quantity specification.

System weight: The systems consist of Ecophon Focus™ Wing elements and Connect™ grid systems, with an approximate weight of 1 kg/m.

Mechanical properties: No additional live load is allowed.

CE: Ecophon ceiling systems are CE marked according to the European harmonized standard EN13964:2014. CE marked construction products are covered by a Declaration of Performance (DOP) which enables customers and users to easily compare performance of products available on the European market.

Installation diagram in detail www.ecophon.com

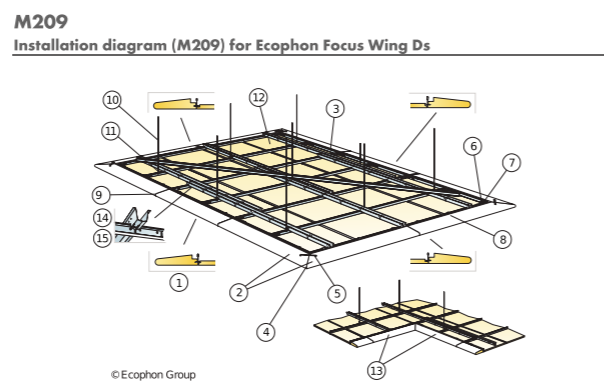
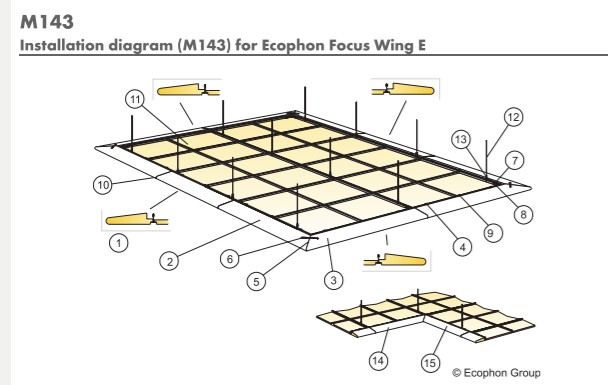

Ecophon Square 43™

Lighting performance:

System effect: 27 W Light source: LED 24,5 W Luminous flux Square Dg, Ds, E: 3281 lm Luminous flux Square Eg, Ez: 2898 lm Light efficiency Square Dg, Ds, E: 121,4 lm/W Light efficiency Square Dg, Ds, E: 108 lm/W Colour temperature: 4000K Color rendering index: Ra ≥80 Colour tolerance: MacAdam ≤3 SDCM Light output ratio (LOR): 100% Light distribution up/down: 0/100 Expected lifespan: L90 >50 000 h Expected lifespan: L70 >100 000 h

Connection: The standard on/off electronic HF ballast delivered with 2,5 meters of cable 3x0,75 mm² and Euro plugg. The SwitchDIM/DALI delivered without cable.

Electrical data: 220-240 V, 50-60 Hz, power factor cos φ>0,98. Electronic HF ballast or electronic HF dim ballast for digital regulation. Light source: led module of 27W total.

Electrical approvals: IP20, Class 1.

Visual appearance: Tile surface finish; White Frost, nearest NCS colour sample S 0500-N, 85% light reflectance. Gloss < 1.

Cleanability: Daily dusting and vacuum cleaning. Weekly wet wiping.

Accessibility: The tiles are easily demountable. Minimum demounting depth according to installation diagrams.

Installation: Installed according to system range which include information regarding minimum overall depth of system. The tile with luminaire housing rests on the T-profiles and the SwitchDIM/DALI and standard on/off ballasts are fastened to the grid or tile next to the luminaire with velcro. Once the tile with luminaire and ballast are in place a certified installation electrician must connect the wiring to sockets or to the next luminaire.

Installation diagram in detail www.ecophon.com

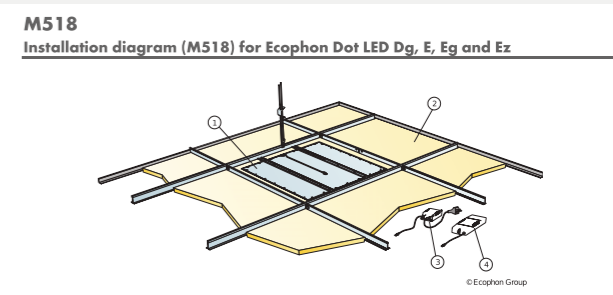
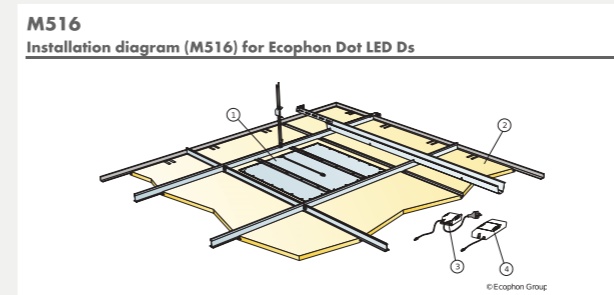

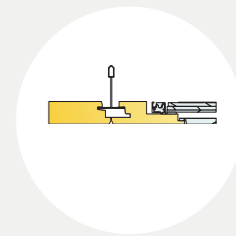
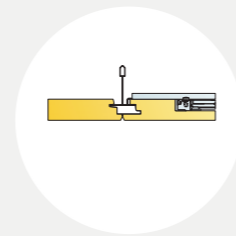

Ecophon Dot™

Lighting performance:

System effect Dot: 27 W Light source: LED 24,5 W Luminous flux Dot Dg, Ds, E: 2936 lm Luminous flux Dot Eg, Ez: 2635 lm Light efficiency Dot Dg, Ds, E: 108,7 lm/W Light efficiency Dot Eg, Ez: 99 lm/W Colour temperature: 4000K Color rendering index: Ra ≥80 Colour tolerance: MacAdam ≤3 SDCM Light output ratio (LOR): 100% Light distribution up/down: 0/100 Expected lifespan: L90 >50 000 h Expected lifespan: L70 >100 000 h

Connection: The standard on/off electronic HF ballast delivered with 2,5 meters of cable 3x0,75 mm² and Euro plugg. The SwitchDIM/DALI delivered without cable.

Electrical data: 220-240 V, 50-60 Hz, power factor cos φ>0,98. Electronic HF ballast or electronic HF dim ballast for digital regulation. Light source: led module of 27W total.

Electrical approvals: IP20, Class 1.

Visual appearance: Tile surface finish; White Frost, nearest NCS colour sample S 0500-N, 85% light reflectance. Gloss < 1.

Cleanability: Daily dusting and vacuum cleaning. Weekly wet wiping.

Accessibility: The tiles are easily demountable. Minimum demounting depth according to installation diagrams.

Installation: Installed according to system range which include information regarding minimum overall depth of system. The tile with luminaire housing rests on the T-profiles and the SwitchDIM/DALI and standard on/off ballasts are fastened to the grid or tile next to the luminaire with velcro. Once the tile with luminaire and ballast are in place a certified installation electrician must connect the wiring to sockets or to the next luminaire.

Installation diagram in detail www.ecophon.com

M516
Installation diagram (M516) for Ecophon Dot LED Ds

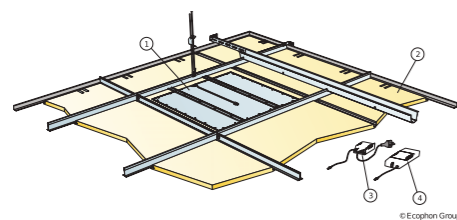

M518
Installation diagram (M518) for Ecophon Dot LED Dg, E, Eg and Ez

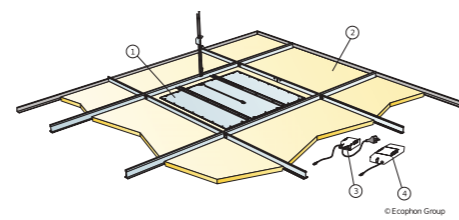

Ecophon Line™

Lighting performance:

System effect: 27 W Light source: LED 24,5 W Luminous flux: 2143 lm Light efficiency: 80,3 lm/W Colour temperature: 4000K Color rendering index: Ra ≥80 Colour tolerance: MacAdam ≤3 SDCM Light output ratio (LOR): 100% Light distribution up/down: 0/100 Expected lifespan: L90 >50 000 h Expected lifespan: L70 >100 000 h

Connection: The standard on/off electronic HF ballast delivered with 2,5 meters of cable 3x0,75 mm² and Euro plugg. The SwitchDIM/DALI delivered without cable.

Electrical data: 220-240 V, 50-60 Hz, power factor cos φ>0,98. Electronic HF ballast or electronic HF dim ballast for digital regulation. Light source: led module of 27W total.

Electrical approvals: IP20, Class 1.

Visual appearance: Tile surface finish; White Frost, nearest NCS colour sample S 0500-N, 85% light reflectance. Gloss < 1.

Cleanability: Daily dusting and vacuum cleaning. Weekly wet wiping.

Accessibility: The tiles are easily demountable. Minimum demounting depth according to installation diagrams.

Installation: Installed according to system range which include information regarding minimum overall depth of system. The tile with luminaire housing rests on the T-profiles and the SwitchDIM/DALI and standard on/off ballasts are fastened to the grid or tile next to the luminaire with velcro. Once the tile with luminaire and ballast are in place a certified installation electrician must connect the wiring to sockets or to the next luminaire.

Installation diagram in detail www.ecophon.com

M517
Installation diagram (M517) for Ecophon Line LED Ds

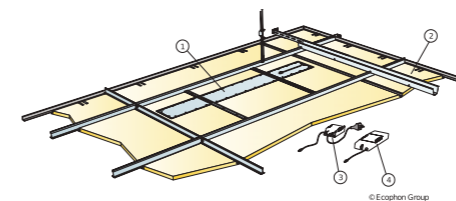

M519
Installation diagram (M519) for Ecophon Line LED Dg and E

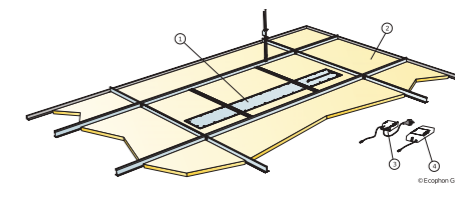

M520
Installation diagram (M520) for Ecophon Line LED Lp

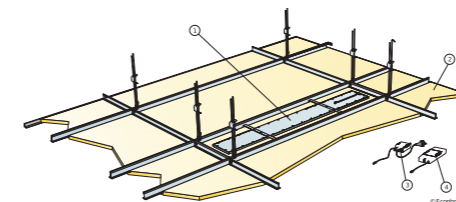

Ecophon is the leading supplier of solutions for indoor acoustic environments that improve working performance, wellbeing and quality of life.

The principles guiding our work are grounded in our Swedish heritage, where a human approach and a common responsibility for people's lives and future challenges come naturally. Ecophon is part of the Saint-Gobain Group, a world leader in sustainable habitat solutions that balance the need for comfort and cost-effectiveness with energy efficiency and environmental responsibility.



– making the world
a better home.



Ecophon[®]
SAINT-GOBAIN

A SOUND EFFECT ON PEOPLE