

Ecophon Solo™

Experiencing freedom of expression



Ecophon®
SAINT-GOBAIN

A SOUND EFFECT ON PEOPLE



This publication shows products from Ecophon product range and those of other suppliers. The specifications are intended to provide a general guide to which products are most suitable for the preferences indicated. Technical data is based on results obtained under typical testing conditions or long experience in normal conditions. The specified functions and properties for products and systems are only valid on condition that instructions, installation diagrams, installation guides, maintenance instructions and other stated conditions and recommendations have been taken into consideration and followed. Deviation from this, such as changing specific components or products, will mean that Ecophon cannot be held responsible for the function, consequences and properties of the products. All descriptions, illustrations and dimensions contained in this brochure represent general information and shall not form part of any contract. Ecophon reserves the right to change products without prior notice. We disclaim any liability for misprints. For the latest information go to www.ecophon.com/uk or contact your nearest Ecophon representative.

© Ecophon Group 2020
Idea and layout: Saint-Gobain Ecophon AB Printer: Skånetryck AB

Content

The Ecophon Group	4
We know acoustics for offices, education and healthcare	5
Good acoustics matter everywhere	6
Acoustic design with Solo	7
Ecophon Solo™ Experiencing freedom of expression	8
Ecophon Solo™ product range	10
Ecophon Solo™ Square	12
Ecophon Solo™ Rectangle	12
Ecophon Solo™ Rectangle Line	13
Ecophon Solo™ Matrix	13
Ecophon Solo™ Circle	14
Ecophon Solo™ Circle XL	14
Ecophon Solo™ Freedom	15
Ecophon Solo™ Textile	15
Ecophon Solo™ Baffle	16
Ecophon Solo™ Baffle Wave	16
Ecophon Solo™ Baffle ZigZag	17
Ecophon Solo™ Baffle Wall	17
Ecophon Solo™ Steel	18
Mounting methods	19
Colours and surfaces	20
Ecophon Solo™ overview	22
System properties Acoustics, technical properties and installation diagrams	24





A sound effect on people

The Ecophon Group

Saint-Gobain Ecophon contributes to good indoor environments for working, healing and learning. We do this by developing, manufacturing and delivering acoustic products and systems. Our promise »A sound effect on people« is at the core of everything we do.

That promise makes every one of us a passionate advocate for the importance of room acoustics to people's wellbeing—whatever the space, activity or need.

It's why we invest in everything from an in-house professor in acoustics, to knowledge-sharing networks and e-learning modules and research projects related to sound, health and the environment.

It's driven us to take the industry lead on innovative use of recyclable and bio-based materials in our products and operate with the least environmental impact possible.

And it informs our core approach of developing acoustic materials and know-how around the natural evolution of human hearing—replicating the outdoor sound experience indoors, because that's just better for people.

In other words, it's not a promise we make lightly. We believe every child deserves an environment that makes learning easier and more fun. That every patient should be spared undue stress, every professional is at their best when they can concentrate, and that every factory worker should feel safe at work.

Having a sound effect on people, in every way we can, is what we do proudly.

“ We are driven by Passion, Competence and Innovation

We know acoustics for offices, education and healthcare

For over 20 years, Ecophon specialists have been collecting and developing a wealth of knowledge in creating sound acoustic environments. Whatever your project, whatever your role, we're happy to share.

Ecophon Concept Developers are experts who specialise in office, education or healthcare environments. They follow academic research, trends in architectural design, cutting-edge building technology, as well as standards and regulations. This knowledge is shared through papers, building studies, articles, guides and much more, and is available to you throughout your project.

Start to finish

We understand how complex building construction is. Ecophon professionals are available to you and your project at every stage of development, from planning to completion.

Knowledge you can use

Ecophon professionals bring an informed and up-to-date perspective that adds value at every stage of your project. Whether you're an investor, developer, architect, acoustician, contractor, installer, or other stakeholder, we can provide the guidance and documentation you need to ensure your project is a success.

People perform at their best in an environment designed around their activity and needs. That's why Ecophon developed Activity Based Acoustic Design. Find the optimal acoustic solution for any activity or space by starting from three perspectives:

Activity

What will people do in the space? Be on the phone, do team work, focus in front of the computer or something else? How much time is spent on communicating?

People

Who will be using the space? Their age, how many and any special needs are all factors to consider.

Space

What are the physical properties of the space? Its size, location in the building, and the building materials used are important to take into account.



Good acoustics matter everywhere

The importance of acoustics is underappreciated. Sound impacts us in daily life, and the scientific support for improving our indoor sound environments is well-documented.

That's not always easy with some spaces. Which is why we developed Ecophon Solo™—a free-hanging range designed to address one of the most common architectural challenges with style.

The Ecophon Solo™ difference

Ecophon Solo combines compelling design with excellent sound absorption. It offers a lot of flexibility for improving acoustic performance in high-ceiling or other spaces where a free-hanging option is best.

Think lobbies, atriums, historic buildings, restaurants or shopping centres, among others. Hanging Ecophon Solo units directly over work areas, receptions and information counters, as well as other strategic points throughout the space, will improve acoustic performance considerably. The more Solo panels installed, the better the sound absorption.





Acoustic design with Ecophon Solo™

Ecophon Solo™ is well-suited to projects where a wall-to-wall solution is undesired or not an option.

Solo panels do not cover the entire ceiling, but the hanging space means both sides of the panel absorb sound, this covers 60% of the ceiling (approximately). Ecophon Solo will give almost the same performance in high frequencies as a wall-to-wall system.

Installing the panels as low as possible, directly over the work area, makes it easier to speak and hear without the sound travelling to disturb others nearby. By adding wall absorbers to any sound-reflecting walls, the results will be even closer to a wall-to-wall solution. This can be achieved by installing as many baffles as possible with no more space than the baffle's height between them.

Solo works well with others

Ecophon Solo™ can also be used to improve an existing wall-to-wall solution that isn't sufficient for the demands. Adding a combination of Solo absorbers and/or baffles will help the existing solution control the spread of sound and lower noise levels even more effectively.

It's usually better to install Solo panels individually, or in clusters, at various points over the whole ceiling area as opposed to concentrating them in one spot. This will dampen and even out sound throughout the space, and lift the overall quality of the acoustic environment.





Ecophon Solo™

Experiencing freedom of expression



The trendy Ecophon Solo™ allows freedom of design and opportunity to create striking visual expressions. The free-hanging panels and system are all 40 mm thick and come in a variety of shapes, colours and sizes you need to fulfil your artistic ideas.

- Superior acoustic qualities
- Available in a wide range of shapes
- Freedom of design with numerous colours, sizes and surface choices

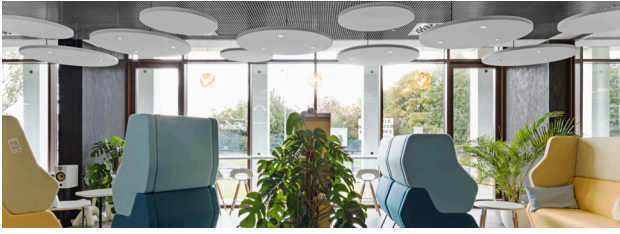

Ecophon Solo™ product range

Solo is the original acoustic cloud with excellent acoustic qualities giving you unlimited creative options to outstanding design with high functionality.

Choose between a variety of shapes, sizes and colours, create your own unique Solo shape or explore the design features of Solo Textile and Solo Steel.

See the world in colour

Enhance your visual statement with the extensive Solo colour range. The Solo family standard colour range includes 20 attractive Akutex™ FT colours, inspired by nature. The colour palette also includes an additional seven Solo Textile colours and four Solo Steel colours.



A shape for every need

Solo is our bravest example of how design and functionality can harmonise to create atmospheres that are pleasing to the eye, the ear and the mind. With several size options and classic shapes, you have all the possibilities to create, whether you like it round, square or rectangular. Big or small.

Freedom to create high-end design

Absolute design creativity with Ecophon Solo™ Freedom. Use our standard shapes or express yourself by creating your own shape. Play with colour and installation alternatives, such as layering, to make an impression with your unique design.



Experience the acoustic cloud sideways

Hanging from the ceiling, baffles can be used to form distinct lines, rolling waves or zig-zag patterns. They add interesting contours and depth to any space when mounted on walls, it is just as easy to mount as it is pleasing to look at.

Ecophon E-tools

Ecophon offers several useful tools and services for the different phases of the building process, from inspiration to specific maintenance instructions

Read more and try our E-tools at www.ecophon.com/uk



Ecophon Solo™ product range

The Solo family is available in numerous colours and a vast range of shapes and sizes. These free-hanging panels are all 40 mm thick and offer excellent acoustic qualities.

Ecophon Solo™ Square

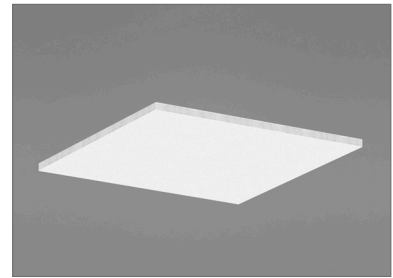

Sizes

1200x1200x40

Ecophon Solo™ Rectangle

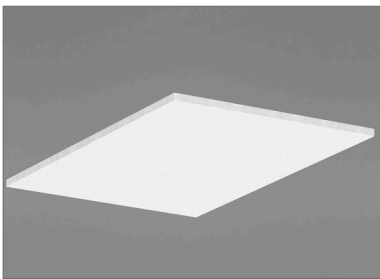

Sizes

1800x1200x40, 2400x600x40,
2400x1200x40, 3000x1200x40

Ecophon Solo™ Rectangle Line

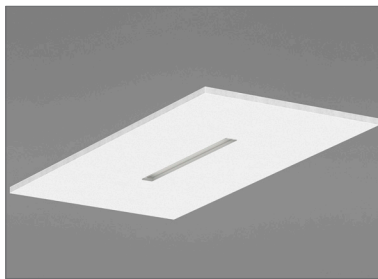

Sizes

2400x1200x40

Ecophon Solo™ Matrix

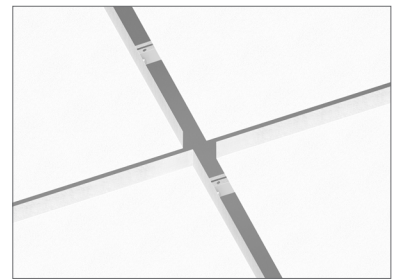

Sizes

Modules: 600x1200x40, 600x2400x40,
1200x1200x40, 2400x1200x40,
Rows: 600x1040x40, 1200x1040x40,
2400x1040x40

Ecophon Solo™ Circle

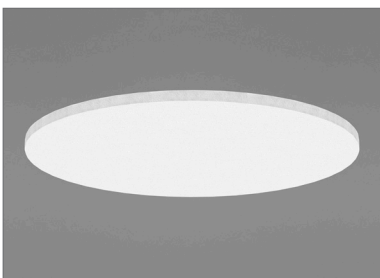

Sizes

Ø800x40, Ø1200x40

Ecophon Solo™ Circle XL

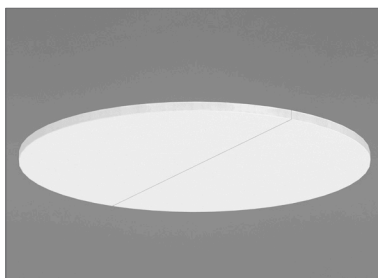

Sizes

Ø1600x40

Ecophon Solo™ Freedom

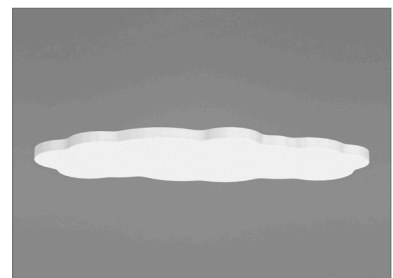

Sizes

≤ 2400x1200x40

Ecophon Solo™ Textile

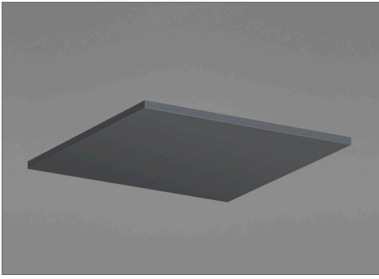

Sizes

1200x1200x40

Ecophon Solo™ Baffle

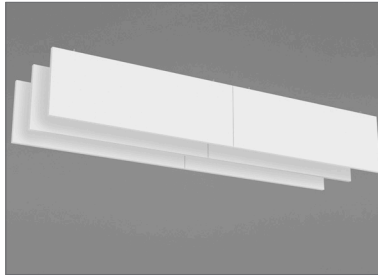

Sizes

1200x200x40, 1200x300x40,
1200x600x40, 1800x200x40,
1800x300x40, 1800x600x40

Ecophon Solo™ Baffle Wave

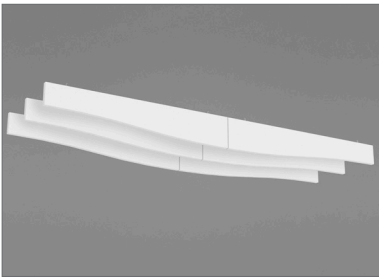

Sizes

1800x300x40, 1800x600x40

Ecophon Solo™ Baffle ZigZag

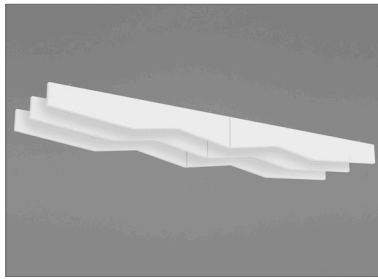

Sizes

1800x300x40, 1800x600x40

Ecophon Solo™ Baffle Wall

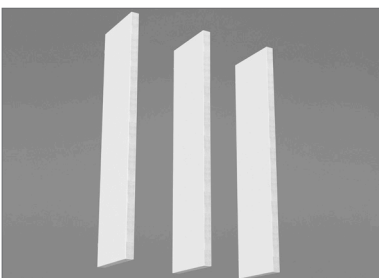

Sizes

1200x200x40, 1200x300x40

Ecophon Solo™ Steel

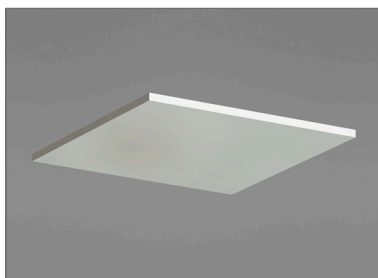

Sizes

1200x1200x40

Our glass wool contains more than

70%
recycled glass

Because of our exceptional raw material and the use of hydroelectric power and biogas, we most probably have the

lowest CO₂
emissions

in the business, per produced square metre of absorber.

100%
recyclable

Superior
fire resistance
A2-s1,d0

Healthy indoor
air quality,
factors that impact our indoor environment:

Indoor air quality
Thermal comfort
Acoustics
Visual or lighting quality

Ecophon lives and breathes acoustic solutions, but did you know that our products also are good for a healthy indoor air quality.

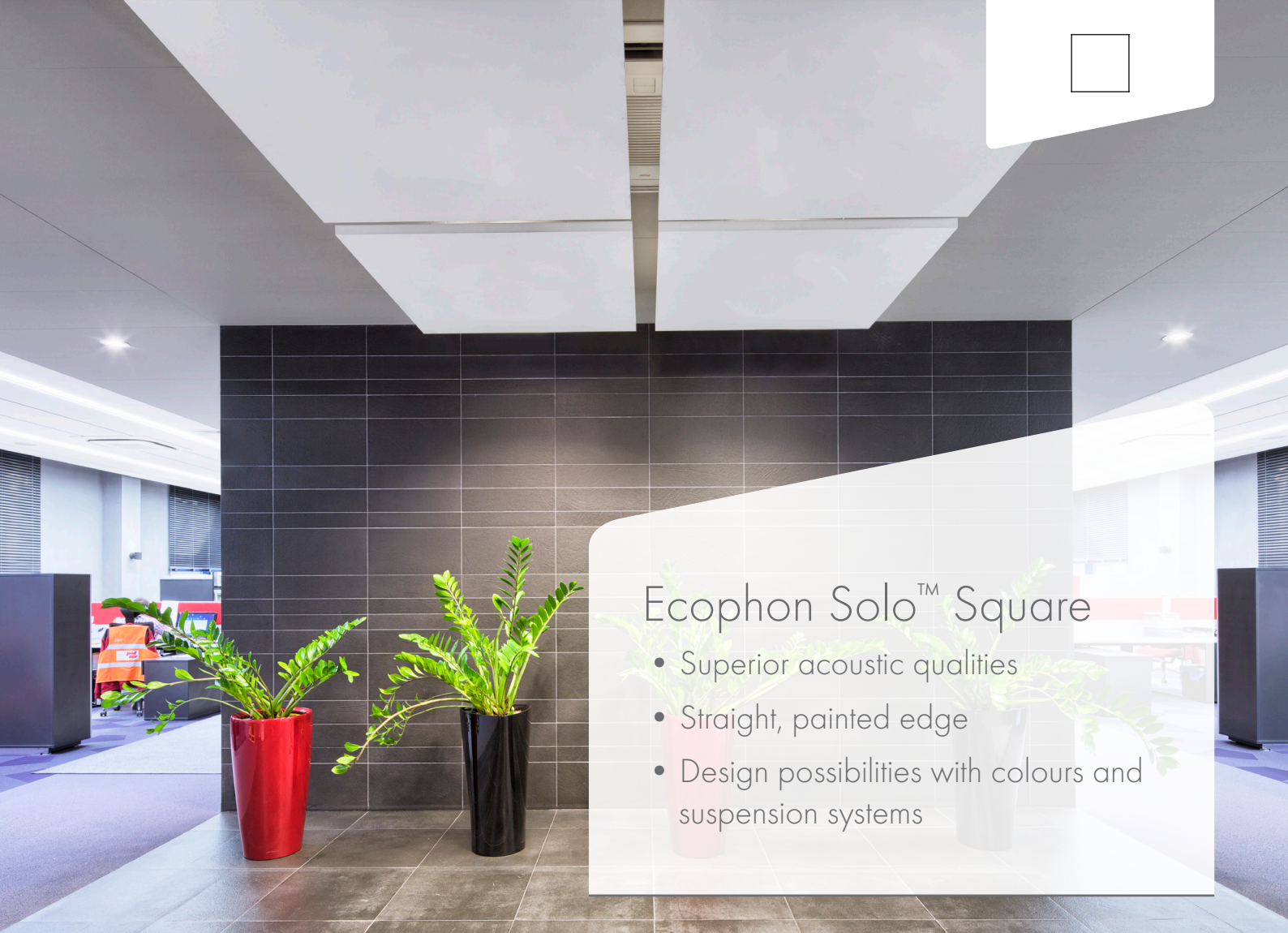

Ecophon Solo™ Square

- Superior acoustic qualities
- Straight, painted edge
- Design possibilities with colours and suspension systems

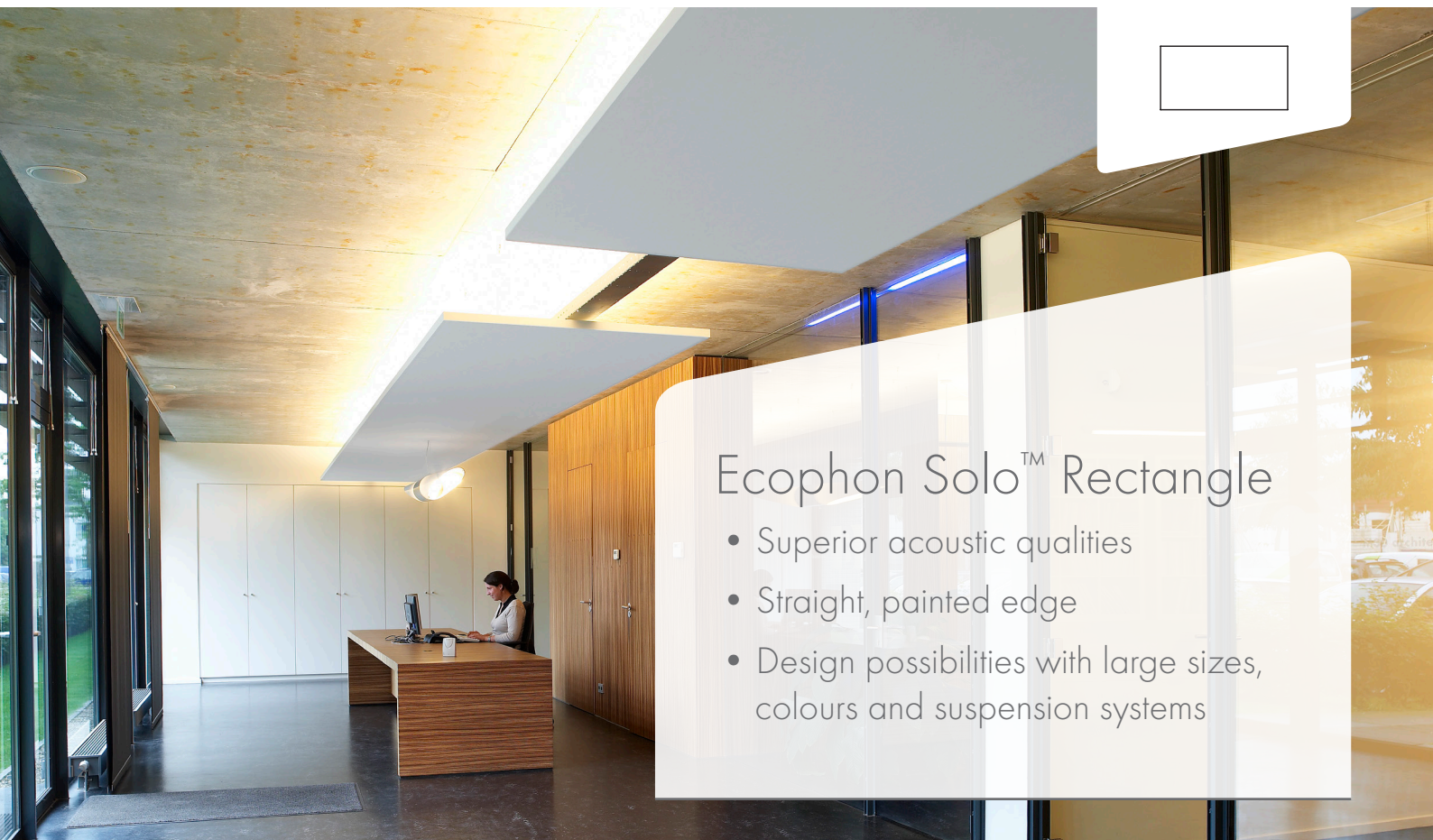

Ecophon Solo™ Rectangle

- Superior acoustic qualities
- Straight, painted edge
- Design possibilities with large sizes, colours and suspension systems



Ecophon Solo™ Rectangle Line

- Superior acoustic qualities
- Straight, painted edge
- Fully integrated recessed luminaire with high level output



Ecophon Solo™ Matrix

- Superior acoustic qualities
- Straight, painted edge
- Free hanging design with patterns in grid for large spaces



Ecophon Solo™ Circle

- Superior acoustic qualities
- Straight, painted edge
- Design possibilities with colours and suspension systems



Ecophon Solo™ Circle XL

- Superior acoustic qualities
- Straight, painted edge
- Design possibilities with colours



Ecophon Solo™ Freedom

- Superior acoustic qualities
- Custom-made shapes with your own design
- 6 creative standard shapes

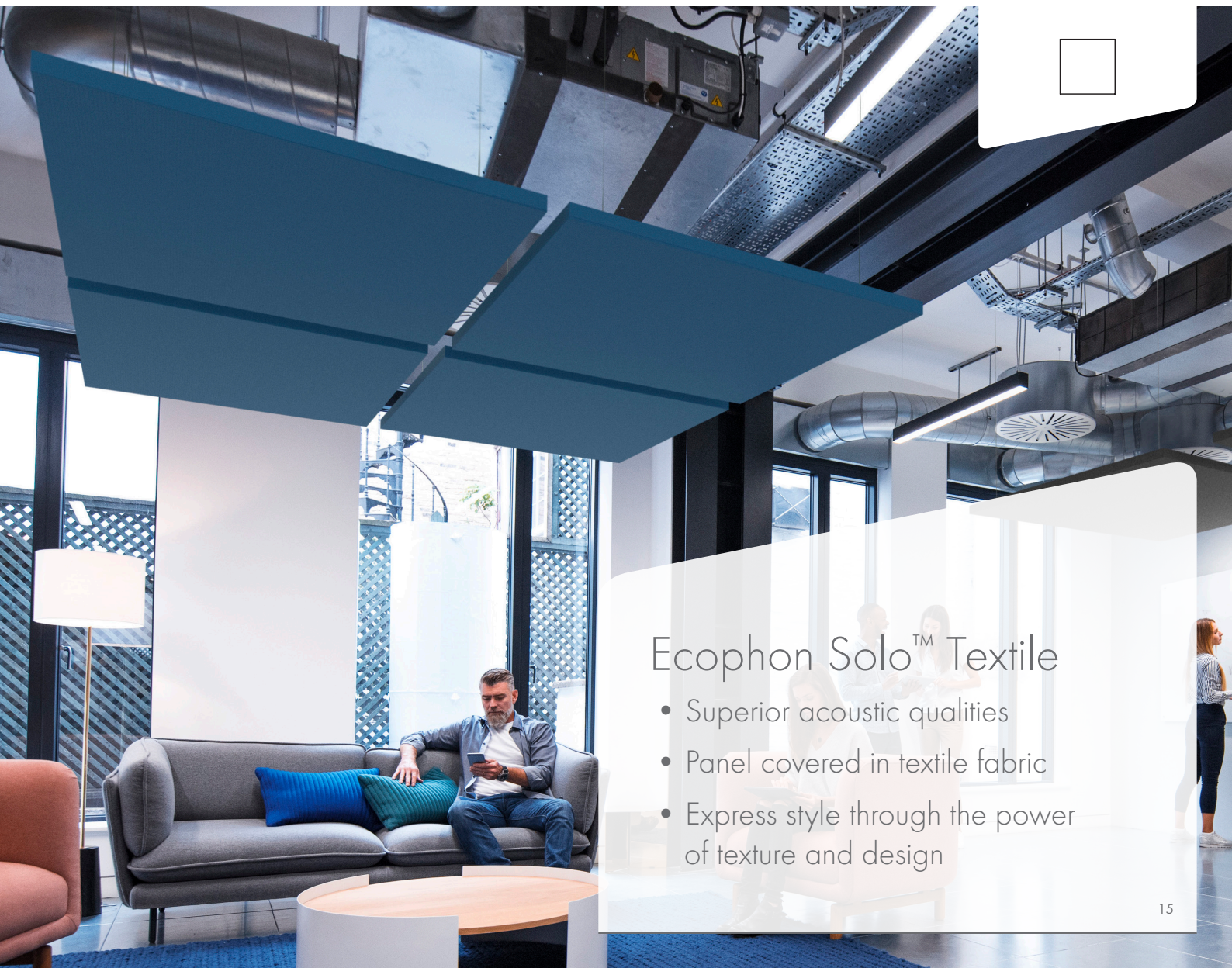

Ecophon Solo™ Textile

- Superior acoustic qualities
- Panel covered in textile fabric
- Express style through the power of texture and design

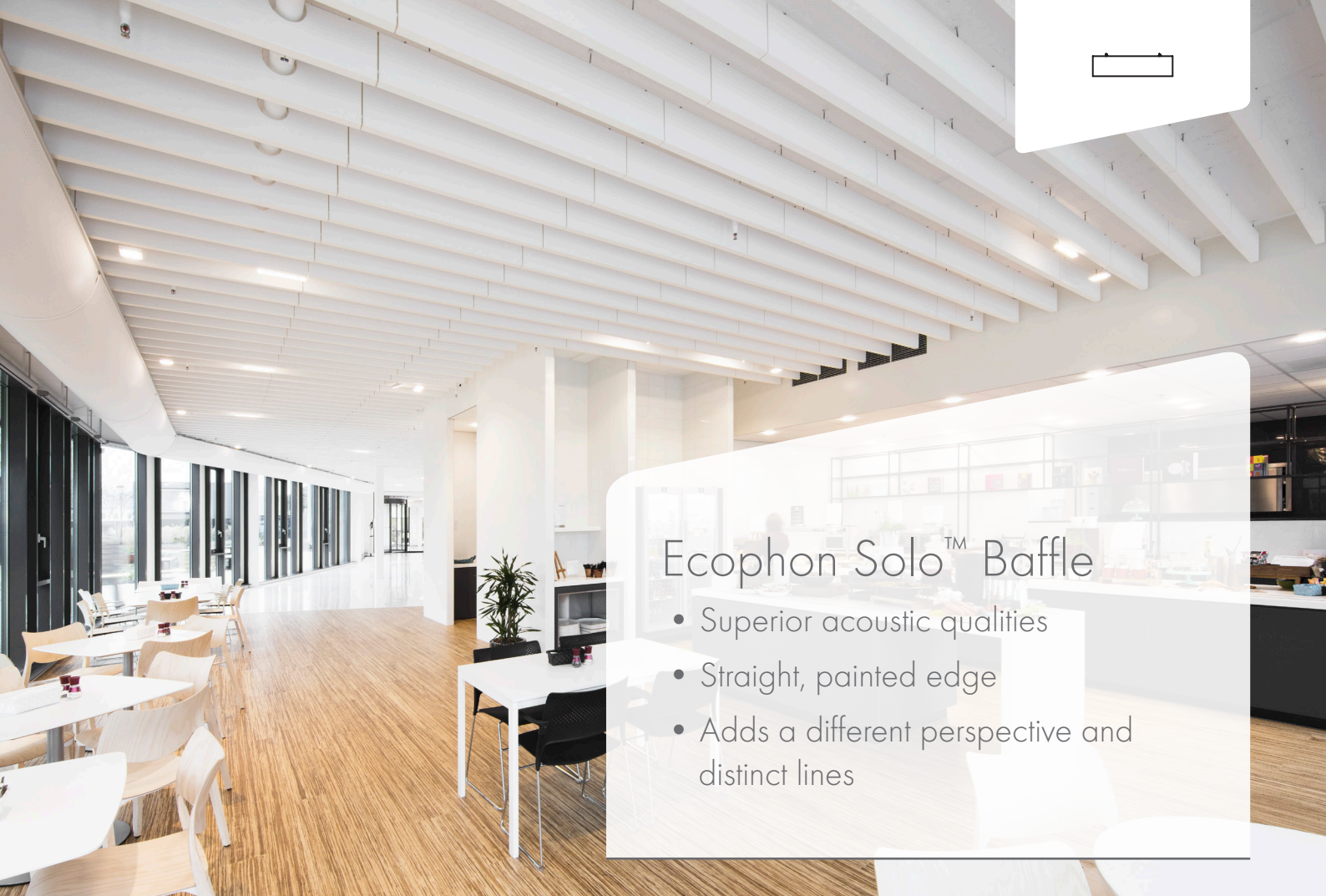

Ecophon Solo™ Baffle

- Superior acoustic qualities
- Straight, painted edge
- Adds a different perspective and distinct lines

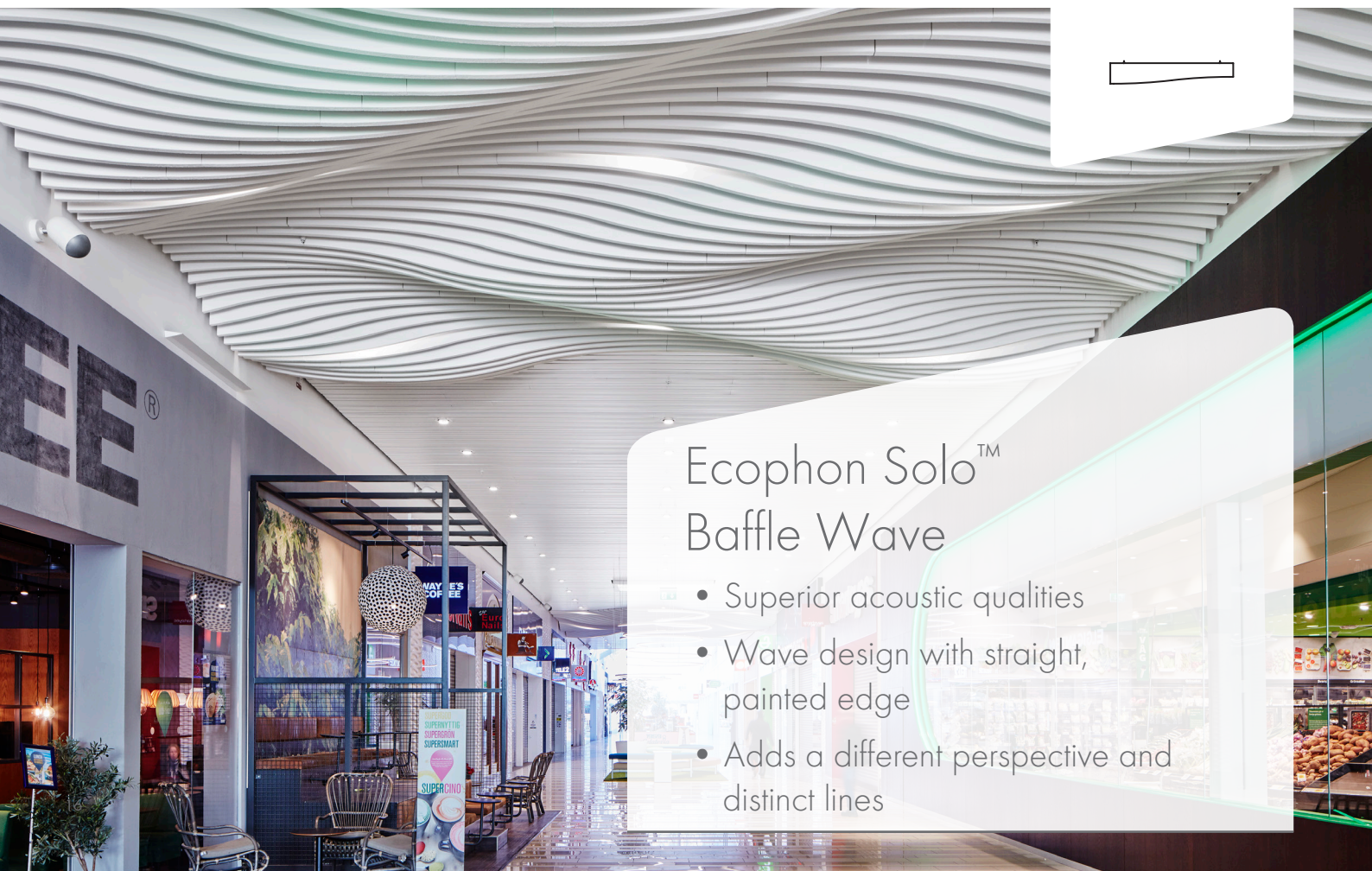

Ecophon Solo™ Baffle Wave

- Superior acoustic qualities
- Wave design with straight, painted edge
- Adds a different perspective and distinct lines



Ecophon Solo™ Baffle ZigZag

- Superior acoustic qualities
- ZigZag design with straight painted edge
- Adds a different perspective and distinct lines



Ecophon Solo™ Baffle Wall

- Superior acoustic qualities
- Straight cut and painted
- Add interesting contours and depth to any space



Ecophon Solo™ Steel

- Superior acoustic qualities
- Covered with perforated steel, painted with powder coating
- A robust design with high performance



A perfect match

Ecophon Akusto™ wall solutions is an excellent complement to further improve the acoustic environment. Akusto solves acoustic challenges whilst also providing opportunities to follow current trends in design and installation. An array of colours and different textured finishes ensure that Akusto is suitable for a range of applications.

Ecophon
— SAINT-GOBAIN

A SOUND EFFECT ON PEOPLE

Mounting methods

Ecophon Solo™ offers a variety of mounting methods to meet market requirements for different installations, both for wall and ceiling. Enjoy freedom of expression with a variety of installation styles.



Direct installation close to the soffit with Connect Absorber Bracket and Connect Absorber Anchor. The brackets are available in adjustable lengths of 50-70 mm and 70-90 mm.

Suspended wire installation with Connect Adjustable Wire Hanger. Suspended wire mounting can also be done with an angle of up to 45° and in multi-levels.

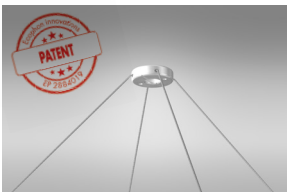

Connect One-point Fixing with Connect Absorber Anchor and Connect Adjustable Wire Hanger. The installation has a discrete design and reduces the amount of fixations in the soffit.

Solo Matrix™ installation can be done in modules or rows with Connect™ grid system. The pre-installed anchors and click-in connection to the grid system gives a free hanging design with the accuracy of a grid system. The Connect Nonius Hangers is available in a range of different lengths.



Baffle installation can be done as direct installation using Solo Baffle Anchor and Connect Baffle Profiles or Connect Baffle Wall Fixing. For suspended mounting Connect Adjustable Wire Hanger or Connect grid system can be used with Solo Baffle Hook.

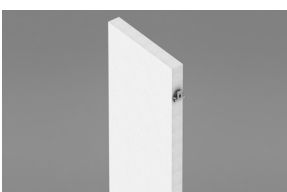

Colours and surfaces

why the colour and surface are important



Akutex™ FT

The Akutex™ label guarantees that the product carrying it has a superior surface technology. Our research and development will always focus on visual aspects, acoustic properties, working environment, architectural trends and environmental aspects. This ensures that Akutex™ is always one step ahead.

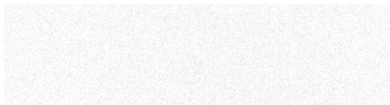

White Frost
Nearest NCS colour sample S 0500-N
Light reflectance 85%.

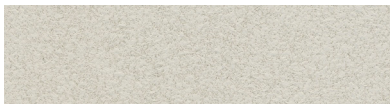

Volcanic Ash
Nearest NCS colour sample 2002-Y
Light reflectance 56%.

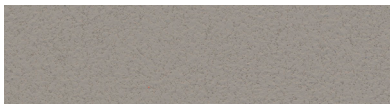

Silver Stone
Nearest NCS colour sample S 4502-Y
Light reflectance 29%.

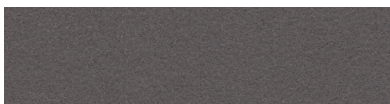

Silk Slate
Nearest NCS colour sample S 7000-N
Light reflectance 13%.



Goji Berry
Nearest NCS colour sample S 3030-Y80R
Light reflectance 27%.



Silent Steam
Nearest NCS colour sample S 2010-B
Light reflectance 45%.

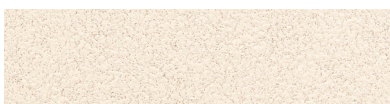

Scallop Shells
Nearest NCS colour sample S 0804-Y50R
Light reflectance 76%.



Ocean Storm
Nearest NCS colour sample S 4020-R90B
Light reflectance 24%.



Moonlight Sky
Nearest NCS colour sample S 7020-R90B
Light reflectance 7%.



Golden Field
Nearest NCS colour sample S 1040-G90Y
Light reflectance 61%.



Sunset Heat
Nearest NCS colour sample S 2070-Y60R
Light reflectance 20%.



Ruby Rock
Nearest NCS colour sample S 4050-R10B
Light reflectance 7%.

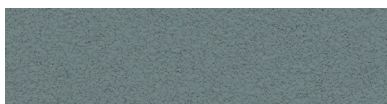

Eucalyptus Leaf
Nearest NCS colour sample S 5010-B30G
Light reflectance 23%.



Summer Forest
Nearest NCS colour sample S 6030-G10Y
Light reflectance 10%.

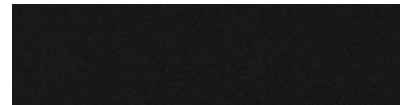

Dark Diamond
Nearest NCS colour sample S 9000-N
Light reflectance 4%.



Morning Drizzle
Nearest NCS colour sample S 1002-B
Light reflectance 69%.

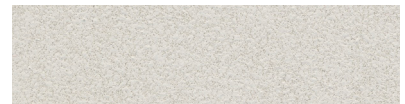

Cloudy Day
Nearest NCS colour sample S 1500-N
Light reflectance 62%.



Peach Rose
Nearest NCS colour sample S 1515-Y80R
Light reflectance 55%.

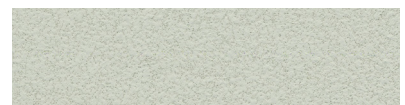

Highland Fog
Nearest NCS colour sample S 2005-G
Light reflectance 55%.

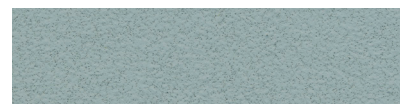

Sage Garden
Nearest NCS colour sample S 3010-B30G
Light reflectance 39%.

Note:
Colours may vary slightly between different production batches.

Reproduction of colours vary between print and reality.

An acoustic ceiling is often the largest continuous surface in a room. This means that it will affect not only the entire look and feel of the interior, but also the **end-users' wellbeing**. Ecophon has developed different types of surfaces and in different colours to suit most types of environments.

Ecophon Textile

Ecophon Textile gives you the ability to create good acoustics that look at once understated and eye catching. The subtle pattern is made from a high-quality knitted material using the pique technique. It's characterised by a texture of fine ribbing, giving it a soft glow when light shines on the surface.



Peaceful
Nearest NCS colour sample S 3010-G80Y
Light reflectance 37%.



Reliable
Nearest NCS colour sample S 3502-Y
Light reflectance 37%.



Curious
Nearest NCS colour sample S 3030-B
Light reflectance 29%.



Confident
Nearest NCS colour sample S 6020-R90B
Light reflectance 9%.



Genuine
Nearest NCS colour sample S 7005-R80B
Light reflectance 10%.



Fearless
Nearest NCS colour sample S 9000-N
Light reflectance 2%.

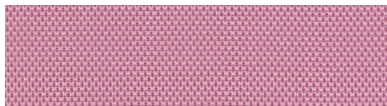

Passionate
Nearest NCS colour sample S 2030-R20B
Light reflectance 33%.

Note:
limited colour variation may occur between batches. Ecophon Textile fabrics have been designed for long durability, regular dusting according to Ecophon specifications and limited exposure to direct UVs are recommended to increase the lifespan of the products. Reproduction of colours vary between print and reality.

Ecophon Steel

Ecophon Steel is a micro-perforated steel surface with powder coating that gives a robust and contemporary feel.

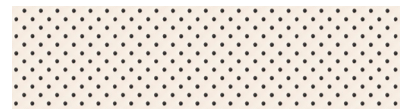

Milky Way
Nearest NCS colour sample S 0500-N
Light reflectance 85%.



Asteroid Grey
Nearest NCS colour sample S 3502-R
Light reflectance 38%.



Endless Space
Nearest NCS colour sample S 9000-N
Light reflectance 2%.

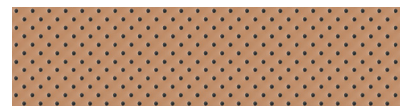









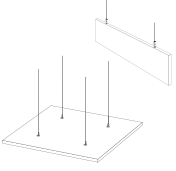
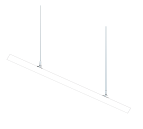

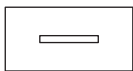

Venus Copper
Nearest NCS colour sample S 3040-Y50R
Light reflectance 22%.

Note:
Colours may vary slightly between different production batches.

Reproduction of colours vary between print and reality.

Ecophon Solo™ overview

Shape	Product	Size, (mm)	Installation methods		
			Direct	Suspended with wire	Suspended with wire, angle $\leq 45^\circ$
					
	Ecophon Solo™ Square	1200x1200x40	•	•	•
	Ecophon Solo™ Rectangle	2400x600x40	•	•	•
		1800x1200x40	•	•	•
		2400x1200x40	•	•	•
		3000x1200x40		•	
	Ecophon Solo™ Rectangle Line	2400x1200x40		•	
	Ecophon Solo™ Matrix (Modules)	600x1200x40			
		600x2400x40			
		1200x1200x40			
		2400x1200x40			
	Ecophon Solo™ Matrix (Rows)	600x1040x40			
		1200x1040x40			
2400x1040x40					
	Ecophon Solo™ Circle	Ø 800x40	•	•	•
		Ø 1200x40	•	•	•
	Ecophon Solo™ Circle XL	Ø 1600x40		•	
	Ecophon Solo™ Freedom	$\leq 2400 \times 1200 \times 40$	•	•	•
	Ecophon Solo™ Textile	1200x1200x40	•	•	
	Ecophon Solo™ Baffle	1200x200x40	•	•	
		1200x300x40	•	•	
		1200x600x40	•	•	
		1800x200x40	•	•	
		1800x300x40	•	•	
		1800x600x40	•	•	
	Ecophon Solo™ Baffle ZigZag	1800x300/200x40	•	•	
		1800x600/300x40	•	•	
	Ecophon Solo™ Baffle Wave	1800x300/200x40	•	•	
		1800x600/300x40	•	•	
	Ecophon Solo™ Baffle Wall	1200x200x40			
		1200x300x40			
	Ecophon Solo™ Steel	1200x1200x40		•	

Suspended, with wire, multi-level	Suspended with wire, one-point	Suspended with Connect™ grid	Suspended in Connect™ grid	Wall	Surface
•	•				Akutex™ FT
•					Akutex™ FT
•					
•	•				
					Akutex™ FT
			•		Akutex™ FT
			•		
			•		
			•		
			•		
			•		
•					Akutex™ FT
•	•				
					Akutex™ FT
•					Akutex™ FT
					Ecophon Textile
		•			Akutex™ FT
		•			
		•			
		•			
		•			
		•			Akutex™ FT
		•			
		•			Akutex™ FT
		•			
				•	Akutex™ FT
				•	
					Ecophon Steel



Ecophon Solo™ panels contribute to a healthy indoor environment with naturally low VOC emissions, as they do not contain any added formaldehyde. As a result, Solo panels comply with the most stringent regulations and certifications in the construction product market – the French VOC A+ and Finnish M1 certifications.

The products do not contribute to fire and the glass wool core of the Solo tiles is tested and classified as non-combustible according to EN ISO 1182. Fire classification according to EN 13501-1, see Technical Properties on respectively product.

All Ecophon Solo products can be dry-wiped and vacuumed daily. The Akutex FT surface can also be wet-wiped weekly.

More product and system information such as installation help and sustainability documentation can be found at www.ecophon.com/uk





System properties

Acoustics, technical properties and
installation diagrams

Ecophon Solo™ Square	26
Ecophon Solo™ Rectangle	28
Ecophon Solo™ Rectangle Line	30
Ecophon Solo™ Matrix	32
Ecophon Solo™ Circle	34
Ecophon Solo™ Circle XL	36
Ecophon Solo™ Freedom	38
Ecophon Solo™ Textile	40
Ecophon Solo™ Baffle	42
Ecophon Solo™ Baffle Wave	44
Ecophon Solo™ Baffle ZigZag	46
Ecophon Solo™ Baffle Wall	48
Ecophon Solo™ Steel	50

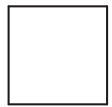

Ecophon Solo™ Square

Acoustic

The values in the diagram refer to a single unit. If the units are arranged in a cluster with distances between units less than 0,5 meters, the Aeq per unit will be slightly reduced.

Sound Absorption:

Test results according to EN ISO 354.

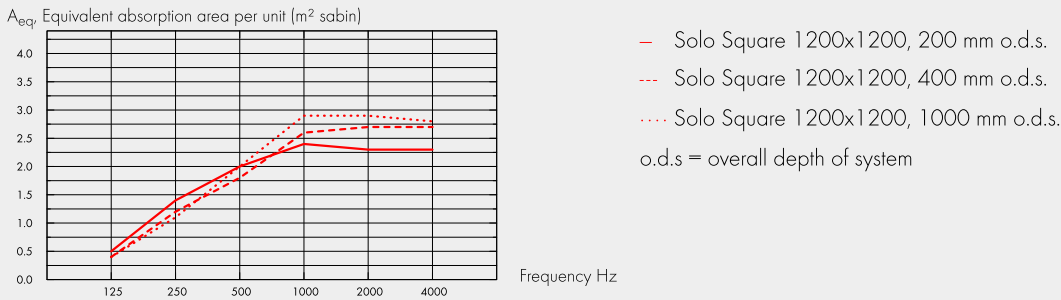

THK mm	o.d.s. mm	A _{eq} Equivalent absorption area per unit (m ² sabin)					
		125 Hz	250 Hz	500 Hz	1000 Hz	2000 Hz	4000 Hz
40	200	0.5	1.4	2.0	2.4	2.3	2.3
40	400	0.4	1.2	1.8	2.6	2.7	2.7
40	1000	0.4	1.1	2.0	2.9	2.9	2.8

Indoor Air Quality: French VOC, A+. Finnish M1.

Environmental Footprint: Kg CO₂ equiv/m²: 8,07 From EPD in conformity with ISO 14025 / EN 15804

Circularity: Fully recyclable

Fire safety: The glass wool core of the tiles is tested and classified as non-combustible according to EN ISO 1182. Europe. EN 13501-1. A2-s1,d0

Humidity Resistance: Class A, relative humidity 70% and 25°C, according to EN 13964:2014

Visual appearance: White Frost, nearest NCS colour sample S 0500-N, 85% light reflectance. Gloss < 1.

Cleanability: Daily dusting and vacuum cleaning. Weekly wet wiping.

Accessibility: The tiles are demountable.

Installation: Installed according to installation diagrams, installation guides and drawing aid. For information regarding minimum overall depth of system see quantity specification.

Mechanical properties: The tile can take both point loads and distributed loads. See Functional demands, Mechanical properties at www.ecophon.com.

CE: Ecophon ceiling systems are CE marked according to the European harmonized standard EN13964:2014. CE marked construction products are covered by a Declaration of Performance (DOP) which enables customers and users to easily compare performance of products available on the European market.

M402

Installation diagram (M402) for Ecophon Solo Square

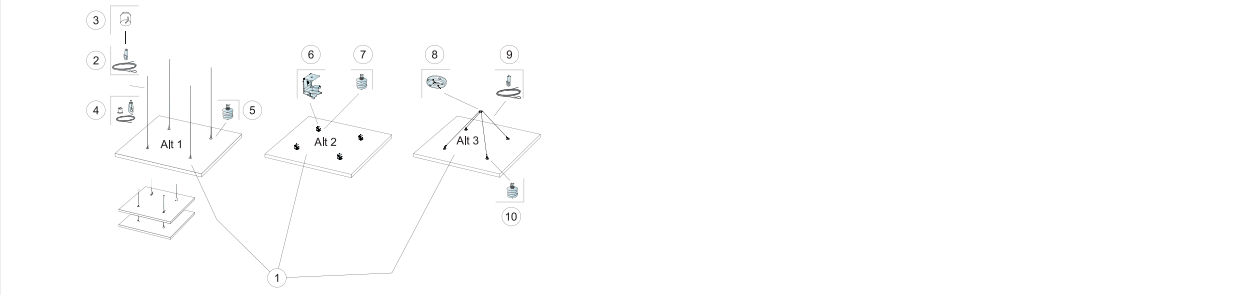



Ecophon Solo™ Rectangle

Acoustic

The values in the diagram refer to a single unit. If the units are arranged in a cluster with distances between units less than 0,5 meters, the Aeq per unit will be slightly reduced.

Sound Absorption:

Test results according to EN ISO 354.

A_{eq} Equivalent absorption area per unit (m² sabin)

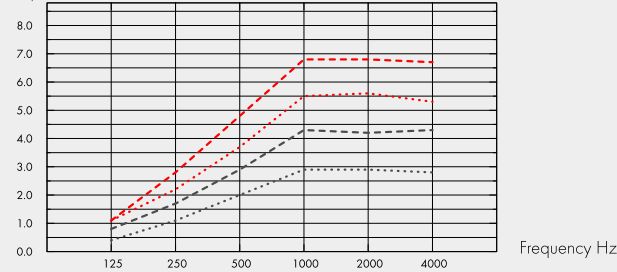

- Solo Rectangle 2400x1200, 1000 mm o.d.s.
 - Solo Rectangle 1800x1200, 1000 mm o.d.s.
 - Solo Rectangle 2400x600, 1000 mm o.d.s.
 - .-.-.- Solo Rectangle 3000x1200, 1000 mm o.d.s.
- o.d.s = overall depth of system

	THK mm	o.d.s. mm	A _{eq} Equivalent absorption area per unit (m ² sabin)					
			125 Hz	250 Hz	500 Hz	1000 Hz	2000 Hz	4000 Hz
2400x1200	40	200	1.3	2.8	3.5	4.1	4.1	3.9
2400x1200	40	400	1.2	2.4	3.3	4.7	4.9	4.7
2400x1200	40	1000	1.1	2.2	3.7	5.5	5.6	5.3
1800x1200	40	200	0.6	2.0	2.9	3.4	3.3	3.1
1800x1200	40	400	0.8	1.9	2.6	3.7	3.7	3.6
1800x1200	40	1000	0.8	1.7	2.9	4.3	4.2	4.3
2400x600	40	200	0.5	1.4	2.0	2.4	2.3	2.3
2400x600	40	400	0.4	1.2	1.8	2.6	2.7	2.7
2400x600	40	1000	0.4	1.1	2.0	2.9	2.9	2.8
3000x1200	40	200	1.1	3.3	4.4	5.1	5.1	5.0
3000x1200	40	400	1.2	3.0	4.2	5.8	5.8	5.7
3000x1200	40	1000	1.1	2.8	4.8	6.8	6.8	6.7

Indoor Air Quality: French VOC, A+. Finnish M1.

Environmental Footprint: Kg CO₂ equiv/m²: 7,96 From EPD in conformity with ISO 14025 / EN 15804

Circularity: Fully recyclable

Fire safety: The glass wool core of the tiles is tested and classified as non-combustible according to EN ISO 1182. Europe. EN 13501-1. A2-s1,d0

Humidity Resistance: Class A, relative humidity 70% and 25°C, according to EN 13964:2014

Visual appearance: White Frost, nearest NCS colour sample S 0500-N, 85% light reflectance. Gloss < 1.

Cleanability: Daily dusting and vacuum cleaning. Weekly wet wiping.

Accessibility: The tiles are demountable.

Installation: Installed according to installation diagrams, installation guides and drawing aid. For information regarding minimum overall depth of system see quantity specification.

Mechanical properties: The tile can take both point loads and distributed loads. See Functional demands, Mechanical properties at www.ecophon.com.

CE: Ecophon ceiling systems are CE marked according to the European harmonized standard EN13964:2014. CE marked construction products are covered by a Declaration of Performance (DOP) which enables customers and users to easily compare performance of products available on the European market.

Installation diagram in detail www.ecophon.com

M404

Installation diagram (M404) for Ecophon Solo Rectangle 1800x1200

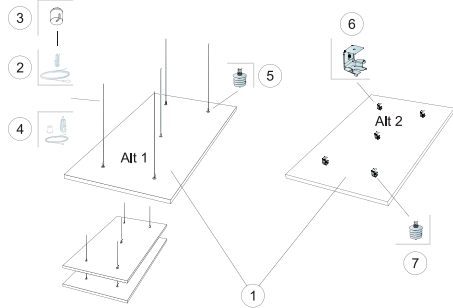

M405

Installation diagram (M405) for Ecophon Solo Rectangle 2400x600

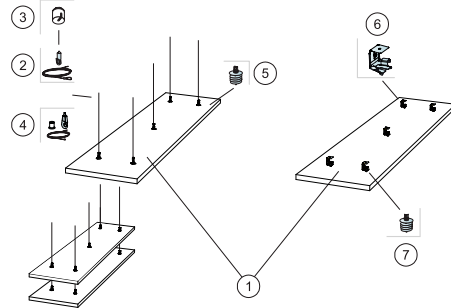

M406

Installation diagram (M406) for Ecophon Solo Rectangle 2400x1200

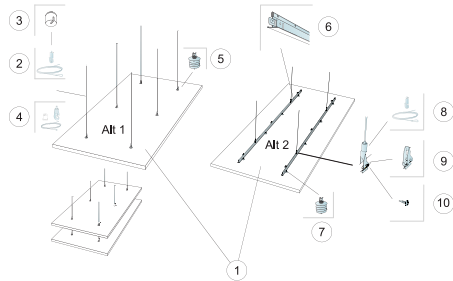

M407

Installation diagram (M407) for Ecophon Solo Rectangle 2400x1200

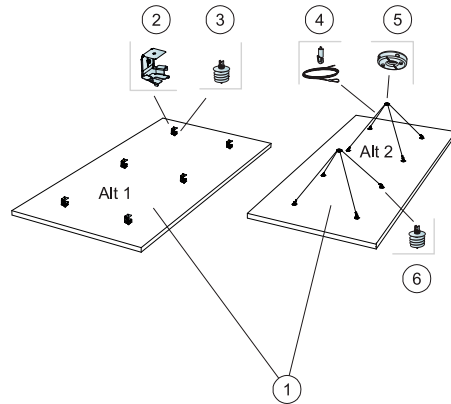

M408

Installation diagram (M408) for Ecophon Solo Rectangle 3000x1200

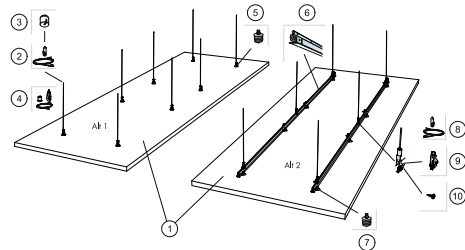

Ecophon Solo™ Rectangle Line

Acoustic: For acoustic data on the panel - please see Solo Rectangle.

Electrical data: 220-240 V, 50-60 Hz, power factor $\cos \phi > 0,98$. Electronic HF ballast or electronic HF dim ballast for digital regulation. Light source: 1 led module of 30W total. Also available as emergency light, with a battery pack for one hour.

Connection: The standard on/off electronic HF ballast delivered with 2,5 meters of cable 3x0,75 mm² and grounded plug. The SwitchDIM/DALI delivered without cable.

Electrical approvals: IP23, Class 1.

Indoor Air Quality: French VOC, A+. Finnish M1.

Fire safety: The glass wool core of the tiles is tested and classified as non-combustible according to EN ISO 1182. Europe. EN 13501-1. A2-s1,d0

Humidity Resistance: Class A, relative humidity 70% and 25°C, according to EN 13964:2014

Visual appearance: White Frost, nearest NCS colour sample S 0500-N, 85% light reflectance. Gloss < 1.

Cleanability: Daily dusting and vacuum cleaning. Weekly wet wiping.

Accessibility: The tiles are demountable.

Installation: Installed according to installation diagrams, installation guides and drawing aid. For information regarding minimum overall depth of system see quantity specification.

CE: Ecophon ceiling systems are CE marked according to the European harmonized standard EN13964:2014. CE marked construction products are covered by a Declaration of Performance (DOP) which enables customers and users to easily compare performance of products available on the European market.

Installation diagram in detail www.ecophon.com

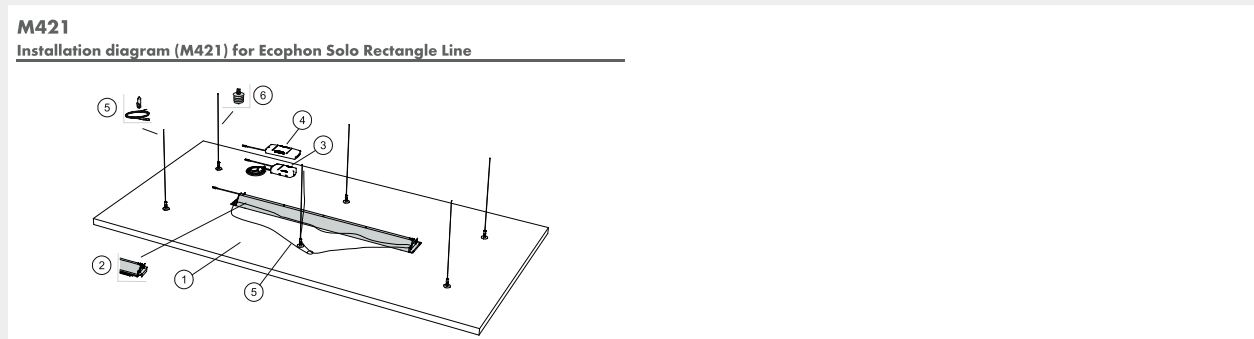



EFFECT ON PEOPLE

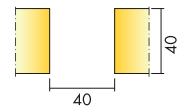

Ecophon Solo™ Matrix

Acoustic

The first diagram refers to clusters >10 m². The second diagram to a cluster of four panels (1200x1040 mm) in a row with a distance of 40 mm. If the clusters are arranged with distances between the clusters <0,5 meters, the Aeq per cluster will be slightly reduced.

Sound Absorption:

Test results according to EN ISO 354. Classification according to EN ISO 11654.

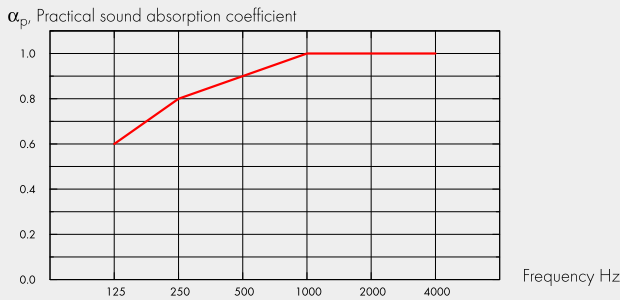

— Solo Matrix 40 mm, 300 mm o.d.s.
o.d.s = overall depth of system

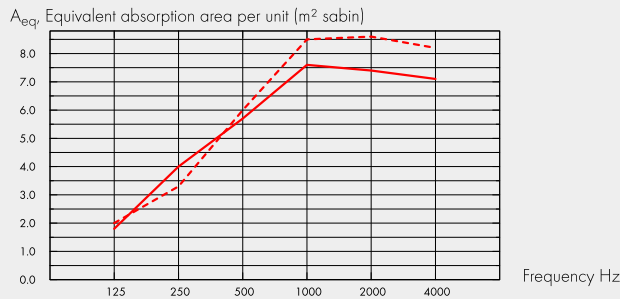

— Solo Matrix 40 mm, 300 mm o.d.s.
- - - Solo Matrix 40 mm, 600 mm o.d.s.
o.d.s = overall depth of system

THK mm	o.d.s. mm	α_p , Practical sound absorption coefficient						α_w	Sound absorption class
		125 Hz	250 Hz	500 Hz	1000 Hz	2000 Hz	4000 Hz		
40	300	0.60	0.80	0.90	1.00	1.00	1.00	A	

THK mm	o.d.s. mm	A_{eq} , Equivalent absorption area per unit (m ² sabin)					
		125 Hz	250 Hz	500 Hz	1000 Hz	2000 Hz	4000 Hz
40	300	1.8	4.0	5.7	7.6	7.4	7.1
40	600	2.0	3.3	6.0	8.5	8.6	8.2

Indoor Air Quality: French VOC, A+. Finnish M1.

Environmental Footprint: Kg CO₂ equiv/m²: 5,79 From EPD in conformity with ISO 14025 / EN 15804

Circularity: Fully recyclable

Fire safety: The glass wool core of the tiles is tested and classified as non-combustible according to EN ISO 1182. Europe. EN 13501-1. A2-s1,d0

Humidity Resistance: Class A, relative humidity 70% and 25°C, according to EN 13964:2014

Visual appearance: White Frost, nearest NCS colour sample S 0500-N, 85% light reflectance. Gloss < 1.

Cleanability: Daily dusting and vacuum cleaning. Weekly wet wiping.

Accessibility: Each panel is individually demountable from below. Panels are equipped with hatch function.

Installation: For design possibilities including installation direction and integrations, see installation guides, installation diagrams and drawing aid. For information regarding minimum overall depth of system see quantity specification.

Mechanical properties: The panels can take small loads with largest aperture diameter of 100 mm. The load is restricted to maximum 250g between two Panel cross bars. For heavier loads see Installation guide.

CE: Ecophon ceiling systems are CE marked according to the European harmonized standard EN13964:2014. CE marked construction products are covered by a Declaration of Performance (DOP) which enables customers and users to easily compare performance of products available on the European market.

Installation diagram in detail www.ecophon.com

M501

Installation diagram (M501) for Ecophon Solo Matrix

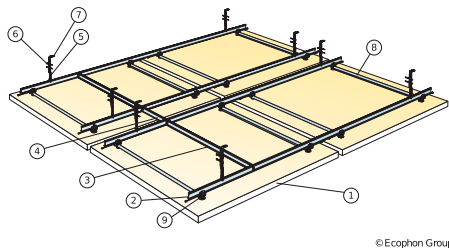

M502

Installation diagram (M502) for Ecophon Solo Matrix in rows

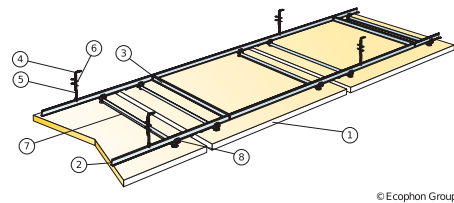

M503

Installation diagram (M503) for Ecophon Solo Matrix

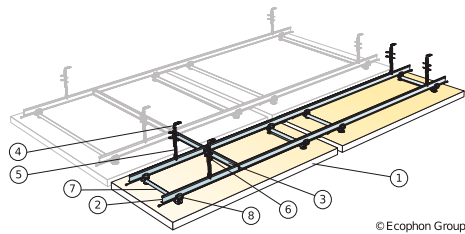

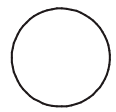

Ecophon Solo™ Circle

Acoustic

The values in the diagram refer to a single unit. If the units are arranged in a cluster with distances between units less than 0,5 meters, the Aeq per unit will be slightly reduced.

Sound Absorption:

Test results according to EN ISO 354.

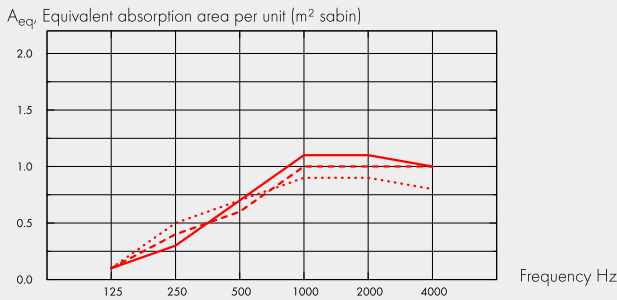

- Solo Circle Ø800, 200 mm o.d.s.
 - - - Solo Circle Ø800, 400 mm o.d.s.
 - ... Solo Circle Ø800, 1000 mm o.d.s.
- o.d.s = overall depth of system

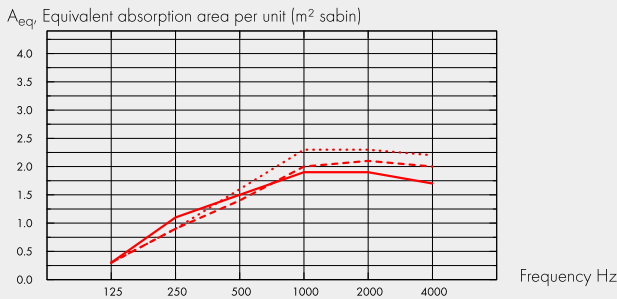

- Solo Circle Ø1200, 200 mm o.d.s.
 - - - Solo Circle Ø1200, 400 mm o.d.s.
 - ... Solo Circle Ø1200, 1000 mm o.d.s.
- o.d.s = overall depth of system

	THK mm	o.d.s. mm	A _{eq} Equivalent absorption area per unit (m ² sabin)					
			125 Hz	250 Hz	500 Hz	1000 Hz	2000 Hz	4000 Hz
Ø800	40	200	0.1	0.3	0.7	1.1	1.1	1.0
Ø800	40	400	0.1	0.4	0.6	1.0	1.0	1.0
Ø800	40	1000	0.1	0.5	0.7	0.9	0.9	0.8
Ø1200	40	200	0.3	1.1	1.5	1.9	1.9	1.7
Ø1200	40	400	0.3	0.9	1.4	2.0	2.1	2.0
Ø1200	40	1000	0.3	0.9	1.6	2.3	2.3	2.2

Indoor Air Quality: French VOC, A+. Finnish M1.

Environmental Footprint: Kg CO₂ equiv/m²: 8,07 From EPD in conformity with ISO 14025 / EN 15804

Circularity: Fully recyclable

Fire safety: The glass wool core of the tiles is tested and classified as non-combustible according to EN ISO 1182. Europe. EN 13501-1. A2-s1,d0

Humidity Resistance: Class A, relative humidity 70% and 25°C, according to EN 13964:2014

Visual appearance: White Frost, nearest NCS colour sample S 0500-N, 85% light reflectance. Gloss < 1.

Cleanability: Daily dusting and vacuum cleaning. Weekly wet wiping.

Accessibility: The tiles are demountable.

Installation: Installed according to installation diagrams, installation guides and drawing aid. For information regarding minimum overall depth of system see quantity specification.

Mechanical properties: The tile can take both point loads and distributed loads. See Functional demands, Mechanical properties at www.ecophon.com.

CE: Ecophon ceiling systems are CE marked according to the European harmonized standard EN13964:2014. CE marked construction products are covered by a Declaration of Performance (DOP) which enables customers and users to easily compare performance of products available on the European market.

Installation diagram in detail www.ecophon.com

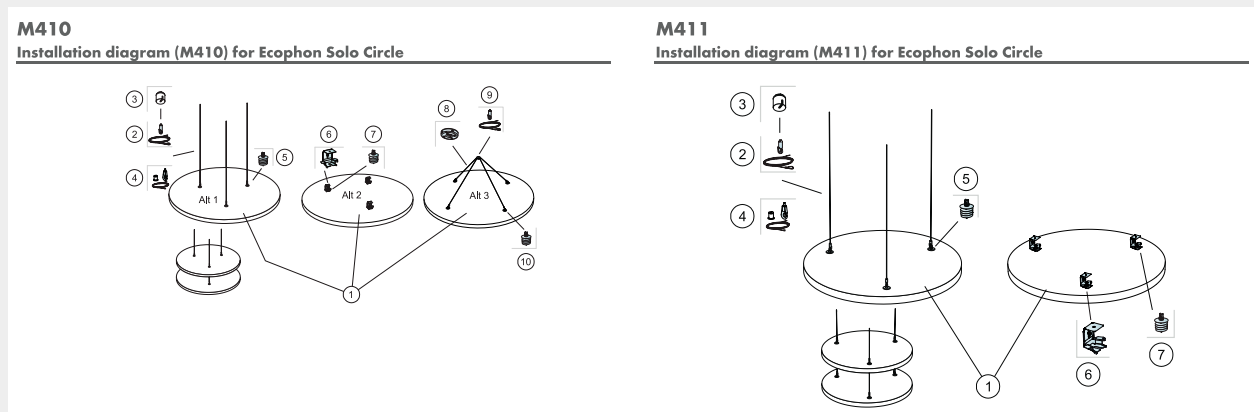

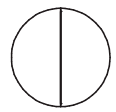

Ecophon Solo™ Circle XL

Acoustic

The values in the diagram refer to a single unit. If the units are arranged in a cluster with distances between units less than 0,5 meters, the Aeq per unit will be slightly reduced.

Sound Absorption:

Test results according to EN ISO 354.

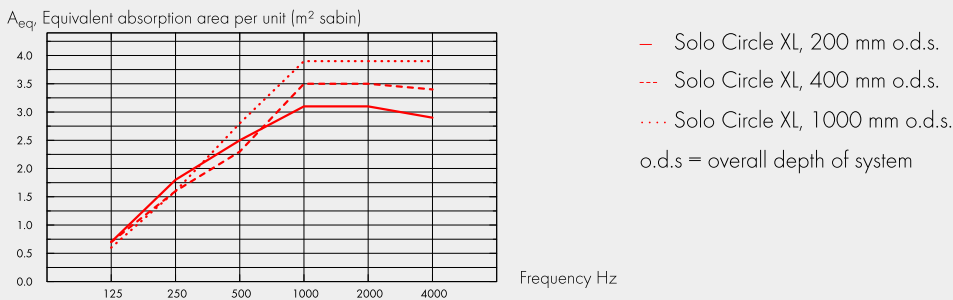

THK mm	o.d.s. mm	A _{eq} Equivalent absorption area per unit (m ² sabin)					
		125 Hz	250 Hz	500 Hz	1000 Hz	2000 Hz	4000 Hz
40	200	0.7	1.8	2.5	3.1	3.1	2.9
40	400	0.7	1.6	2.3	3.5	3.5	3.4
40	1000	0.6	1.6	2.8	3.9	3.9	3.9

Indoor Air Quality: French VOC, A+. Finnish M1.

Circularity: Fully recyclable

Fire safety: The glass wool core of the tiles is tested and classified as non-combustible according to EN ISO 1182. Europe. EN 13501-1. A2-s1,d0

Humidity Resistance: Class A, relative humidity 70% and 25°C, according to EN 13964:2014

Visual appearance: White Frost, nearest NCS colour sample S 0500-N, 85% light reflectance. Gloss < 1.

Cleanability: Daily dusting and vacuum cleaning. Weekly wet wiping.

Accessibility: The tiles are demountable.

Installation: Installed according to installation diagrams, installation guides and drawing aid. For information regarding minimum overall depth of system see quantity specification.

Mechanical properties: No additional live load is allowed.

CE: Ecophon ceiling systems are CE marked according to the European harmonized standard EN13964:2014. CE marked construction products are covered by a Declaration of Performance (DOP) which enables customers and users to easily compare performance of products available on the European market.

M290

Installation diagram (M290) for Ecophon Solo Circle XL

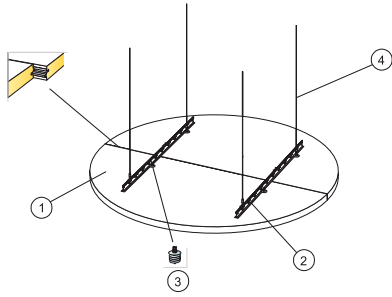

© Ecophon Group



Ecophon Solo™ Freedom

Acoustic: For acoustic data on the panel - please see Solo Square and Rectangle.

Indoor Air Quality: French VOC, A+. Finnish M1.

Environmental Footprint: Kg CO₂ equiv/m²: 8,07 From EPD in conformity with ISO 14025 / EN 15804

Circularity: Fully recyclable

Fire safety: The glass wool core of the tiles is tested and classified as non-combustible according to EN ISO 1182. Europe. EN 13501-1. A2-s1,d0

Humidity Resistance: Class A, relative humidity 70% and 25°C, according to EN 13964:2014

Visual appearance: White Frost, nearest NCS colour sample S 0500-N, 85% light reflectance. Gloss < 1.

Cleanability: Daily dusting and vacuum cleaning. Weekly wet wiping.

Accessibility: The tiles are demountable.

Installation: Installed according to installation diagrams, installation guides and drawing aid. For information regarding minimum overall depth of system see quantity specification.

Mechanical properties: The tile can take both point loads and distributed loads. See Functional demands, Mechanical properties at www.ecophon.com.

CE: Ecophon ceiling systems are CE marked according to the European harmonized standard EN13964:2014. CE marked construction products are covered by a Declaration of Performance (DOP) which enables customers and users to easily compare performance of products available on the European market.

Installation diagram in detail www.ecophon.com

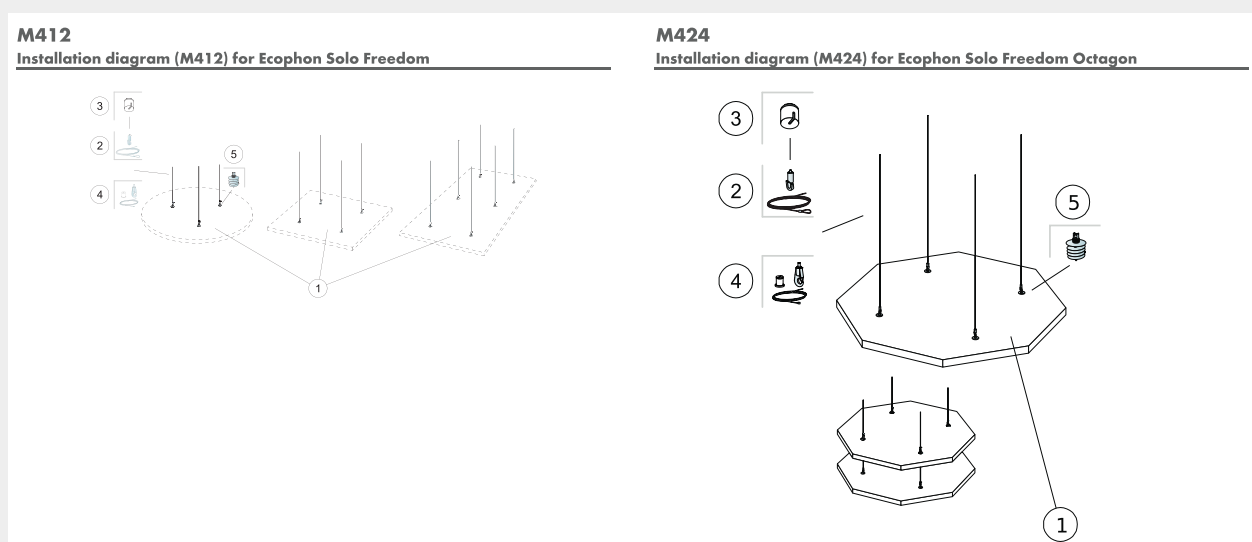

M425

Installation diagram (M425) for Ecophon Solo Heptagon

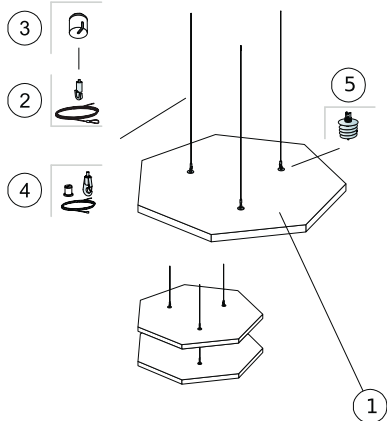

M426

Installation diagram (M426) for Ecophon Solo Hexagon

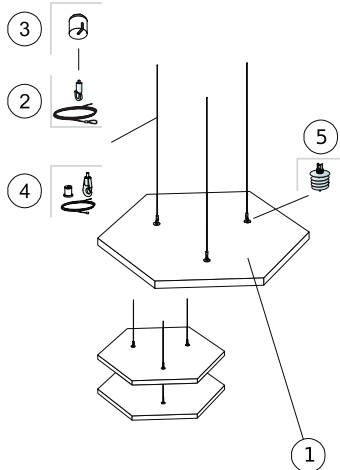

M427

Installation diagram (M427) for Ecophon Solo Pentagon

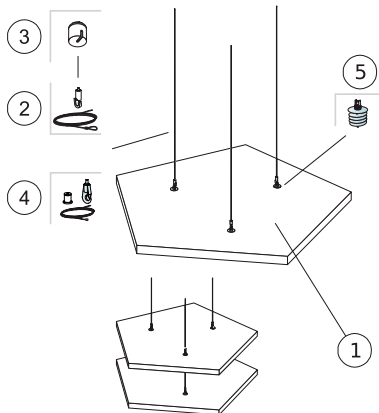

M428

Installation diagram (M428) for Ecophon Solo Ellipse

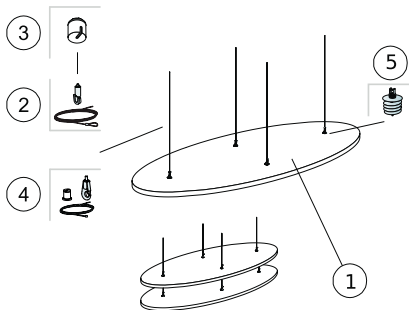

M297

Installation diagram (M297) for Ecophon Solo Triangle

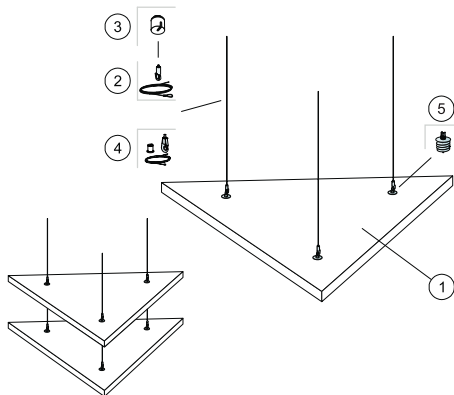

Ecophon Solo™ Textile

Acoustic

The values in the diagram refer to a single unit. If the units are arranged in a cluster with distances between units less than 0,5 meters, the Aeq per unit will be slightly reduced.

Sound Absorption:

Test results according to EN ISO 354.

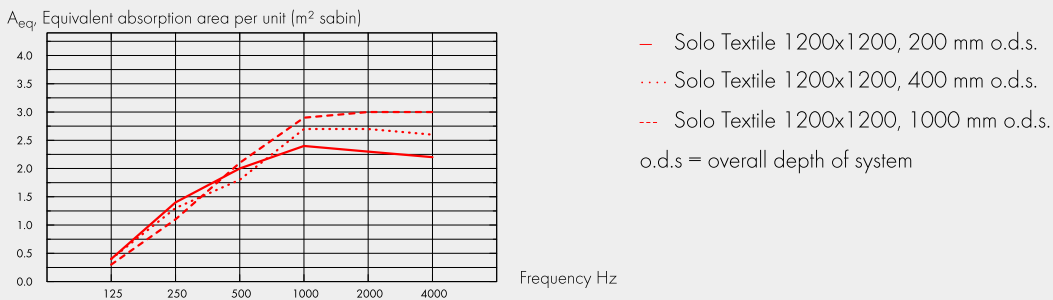

	THK mm	o.d.s. mm	A _{eq} Equivalent absorption area per unit (m ² sabin)					
			125 Hz	250 Hz	500 Hz	1000 Hz	2000 Hz	4000 Hz
1200x1200	40	200	0.4	1.4	2.0	2.4	2.3	2.2
1200x1200	40	400	0.4	1.3	1.8	2.7	2.7	2.6
1200x1200	40	1000	0.3	1.1	2.1	2.9	3.0	3.0

Indoor Air Quality: French VOC, A.

Circularity: Fully recyclable

Fire safety: The glass wool core of the tiles is tested and classified as non-combustible according to EN ISO 1182. Europe. EN 13501-1. B-s1,d0

Humidity Resistance: Class A, relative humidity 70% and 25°C, according to EN 13964:2014

Visual appearance: Light reflectance and nearest NCS colour sample for all the different colours: See Ecophon Colours and surfaces. (The tiles need to be installed in accordance with the installation guide in order to get optimal visual appearance).

Cleanability: Weekly dusting and vacuum cleaning.

Accessibility: The tiles are demountable.

Installation: Installed according to installation diagrams, installation guides and drawing aid. For information regarding minimum overall depth of system see quantity specification.

Mechanical properties: No additional live load is allowed.

CE: Ecophon ceiling systems are CE marked according to the European harmonized standard EN13964:2014. CE marked construction products are covered by a Declaration of Performance (DOP) which enables customers and users to easily compare performance of products available on the European market.

M482

Installation diagram (M482) for Ecophon Solo Textile

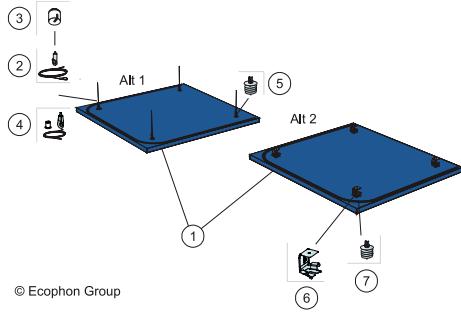



Ecophon Solo™ Baffle

Acoustic

Sound Absorption:

Test results according to EN ISO 354:2003 NOTE: Results shown are not comparable with results according to older versions of this standard due to discrepancies in test method. Classification according to EN ISO 11654, and the single value ratings for Noise Reduction Coefficient, NRC and Sound Absorption Average, SAA according to ASTM C 423.

α_p , Practical sound absorption coefficient

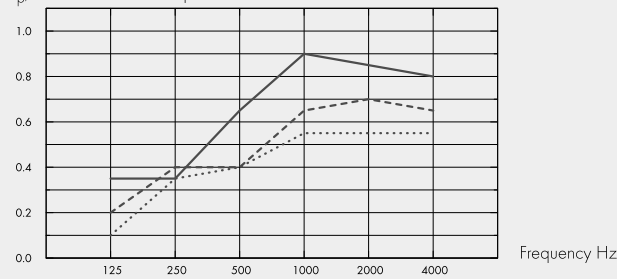

- Solo Baffle 1200/1800x200, spacing 600mm, direct mounting
 - Solo Baffle 1200/1800x300, spacing 600mm, direct mounting
 - Solo Baffle 1200/1800x600, spacing 600mm, direct mounting
- o.d.s = overall depth of system

A_{eq} , Equivalent absorption area per unit (m² sabin)

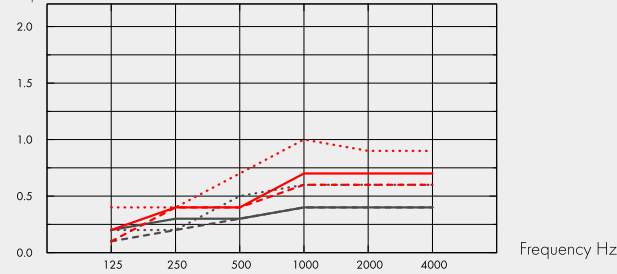

- Solo Baffle 1200x200
 - Solo Baffle 1200x300
 - Solo Baffle 1200x600
 - Solo Baffle 1800x200
 - Solo Baffle 1800x300
 - Solo Baffle 1800x600
- o.d.s = overall depth of system

	THK mm	o.d.s. mm	α_p , Practical sound absorption coefficient						α_w
			125 Hz	250 Hz	500 Hz	1000 Hz	2000 Hz	4000 Hz	
c600	40	200	0.10	0.35	0.40	0.55	0.55	0.55	0.50
c600	40	300	0.20	0.40	0.40	0.65	0.70	0.65	0.50
c600	40	600	0.35	0.35	0.65	0.90	0.85	0.80	0.65

	THK mm	o.d.s. mm	A_{eq} , Equivalent absorption area per unit (m ² sabin)					
			125 Hz	250 Hz	500 Hz	1000 Hz	2000 Hz	4000 Hz
1200x200c600	40	200	0.1	0.2	0.3	0.4	0.4	0.4
1200x300c600	40	300	0.2	0.3	0.3	0.4	0.4	0.4
1200x600c600	40	600	0.2	0.2	0.5	0.6	0.6	0.6
1800x200c600	40	200	0.1	0.4	0.4	0.6	0.6	0.6
1800x300c600	40	300	0.2	0.4	0.4	0.7	0.7	0.7
1800x600c600	40	600	0.4	0.4	0.7	1.0	0.9	0.9

Indoor Air Quality: French VOC, A+. Finnish M1.

Environmental Footprint: Kg CO₂ equiv/m²: 8,07 From EPD in conformity with ISO 14025 / EN 15804

Circularity: Fully recyclable

Fire safety: The glass wool core of the tiles is tested and classified as non-combustible according to EN ISO 1182. Europe. EN 13501-1. A2-s1,d0

Humidity Resistance: Class A, relative humidity 70% and 25°C, according to EN 13964:2014

Visual appearance: White Frost, nearest NCS colour sample S 0500-N, 85% light reflectance. Gloss < 1.

Cleanability: Daily dusting and vacuum cleaning. Weekly wet wiping.

Accessibility: The tiles are demountable.

Installation: Installed according to installation diagrams, installation guides and drawing aid. For information regarding minimum overall depth of system see quantity specification.

Mechanical properties: Additional live load has to be fixed to the soffit.

CE: Ecophon ceiling systems are CE marked according to the European harmonized standard EN13964:2014. CE marked construction products are covered by a Declaration of Performance (DOP) which enables customers and users to easily compare performance of products available on the European market.

Installation diagram in detail www.ecophon.com

M414

Installation diagram (M414) for Ecophon Solo Baffle/anchor

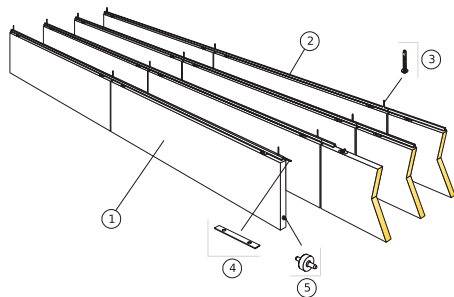

M491

Installation diagram (M491) for Ecophon Solo Baffle/hook

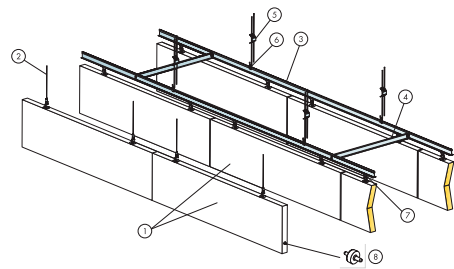

© Ecophon Group

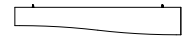

Ecophon Solo™ Baffle Wave

Acoustic

Sound Absorption:

Test results according to EN ISO 354:2003 NOTE: Results shown are not comparable with results according to older versions of this standard due to discrepancies in test method. Classification according to EN ISO 11654, and the single value ratings for Noise Reduction Coefficient, NRC and Sound Absorption Average, SAA according to ASTM C 423.

α_p , Practical sound absorption coefficient

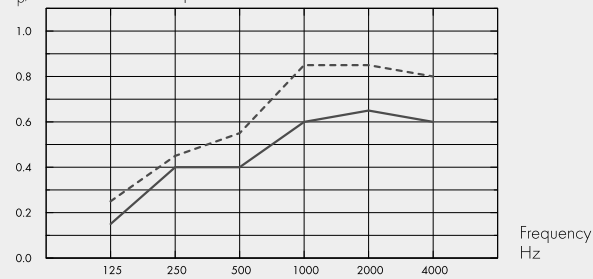

- Solo Baffle Wave 1800x300/200, spacing 600, direct mounting
 - Solo Baffle Wave 1800x600/300, spacing 600, direct mounting
- o.d.s = overall depth of system

A_{eq} , Equivalent absorption area per unit (m² sabin)

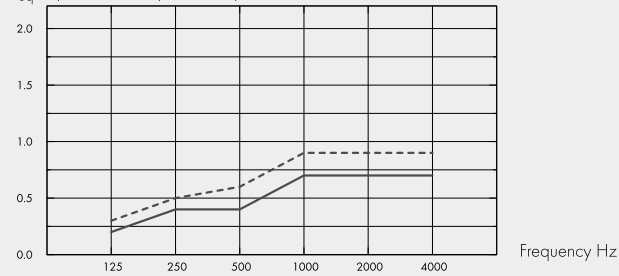

- Solo Baffle Wave 1800x300/200
 - Solo Baffle Wave 1800x600/300
- o.d.s = overall depth of system

	THK mm	o.d.s. mm	A_{eq} Equivalent absorption area per unit (m ² sabin)					
			125 Hz	250 Hz	500 Hz	1000 Hz	2000 Hz	4000 Hz
c600	40	200	0.2	0.4	0.4	0.7	0.7	0.7
c600	40	300	0.3	0.5	0.6	0.9	0.9	0.9

	THK mm	o.d.s. mm	α_p , Practical sound absorption coefficient						α_w
			125 Hz	250 Hz	500 Hz	1000 Hz	2000 Hz	4000 Hz	
c600	40	200	0.15	0.40	0.40	0.60	0.65	0.60	0.50
c600	40	300	0.25	0.45	0.55	0.85	0.85	0.80	0.65

	THK mm	o.d.s. mm	NRC	SAA
c600	40	200	0.50	0.52
c600	40	300	0.70	0.68

Indoor Air Quality: French VOC, A+. Finnish M1.

Environmental Footprint: Kg CO₂ equiv/m²: 8,07 From EPD in conformity with ISO 14025 / EN 15804

Circularity: Fully recyclable

Fire safety: The glass wool core of the tiles is tested and classified as non-combustible according to EN ISO 1182. Europe. EN 13501-1. A2-s1,d0

Humidity Resistance: Class A, relative humidity 70% and 25°C, according to EN 13964:2014

Visual appearance: White Frost, nearest NCS colour sample S 0500-N, 85% light reflectance. Gloss < 1.

Cleanability: Daily dusting and vacuum cleaning. Weekly wet wiping.

Accessibility: The tiles are demountable.

Installation: Installed according to installation diagrams, installation guides and drawing aid. For information regarding minimum overall depth of system see quantity specification.

Mechanical properties: Additional live load has to be fixed to the soffit.

CE: Ecophon ceiling systems are CE marked according to the European harmonized standard EN13964:2014. CE marked construction products are covered by a Declaration of Performance (DOP) which enables customers and users to easily compare performance of products available on the European market.

Installation diagram in detail www.ecophon.com

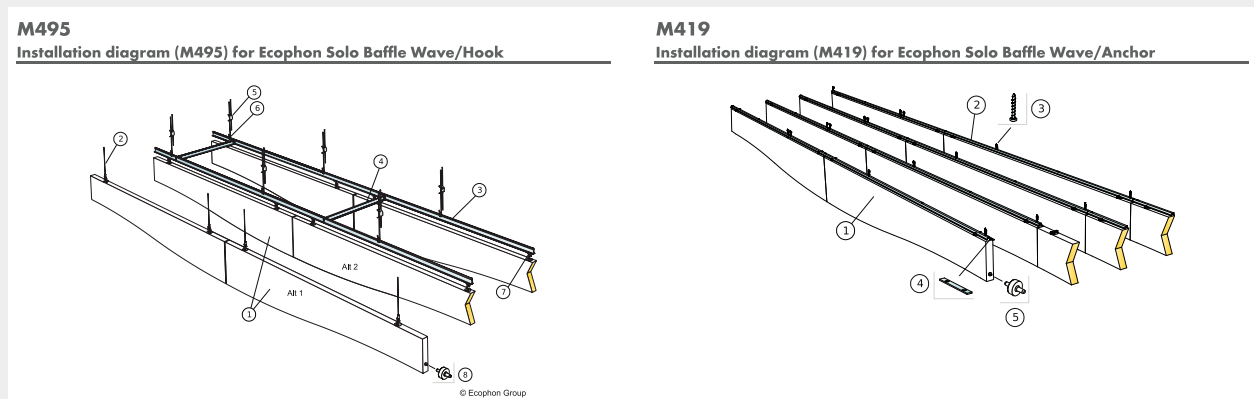

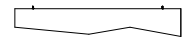

Ecophon Solo™ Baffle ZigZag

Acoustic

Sound Absorption:

Test results according to EN ISO 354:2003 NOTE: Results shown are not comparable with results according to older versions of this standard due to discrepancies in test method. Classification according to EN ISO 11654, and the single value ratings for Noise Reduction Coefficient, NRC and Sound Absorption Average, SAA according to ASTM C 423.

α_p , Practical sound absorption coefficient

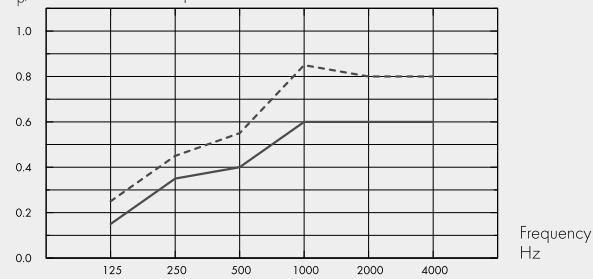

- Solo Baffle ZigZag 1800x300/200, spacing 600, direct mounting
- Solo Baffle ZigZag 1800x600/300, spacing 600, direct mounting
- o.d.s = overall depth of system

A_{eq} , Equivalent absorption area per unit (m² sabin)

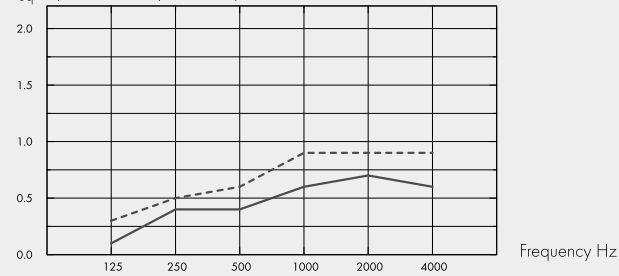

- Solo Baffle ZigZag 1800x300/200
- Solo Baffle ZigZag 1800x600/300
- o.d.s = overall depth of system

	THK mm	o.d.s. mm	α_p , Practical sound absorption coefficient						α_w
			125 Hz	250 Hz	500 Hz	1000 Hz	2000 Hz	4000 Hz	
c600	40	200	0.15	0.35	0.40	0.60	0.60	0.60	0.50
c600	40	300	0.25	0.45	0.55	0.85	0.80	0.80	0.65

	THK mm	o.d.s. mm	A_{eq} , Equivalent absorption area per unit (m ² sabin)					
			125 Hz	250 Hz	500 Hz	1000 Hz	2000 Hz	4000 Hz
c600	40	200	0.1	0.4	0.4	0.6	0.7	0.6
c600	40	300	0.3	0.5	0.6	0.9	0.9	0.9

	THK mm	o.d.s. mm	NRC	SAA
c600	40	200	0.50	0.49
c600	40	300	0.65	0.65

Indoor Air Quality: French VOC, A+. Finnish M1.

Environmental Footprint: Kg CO₂ equiv/m²: 8,07 From EPD in conformity with ISO 14025 / EN 15804

Circularity: Fully recyclable

Fire safety: The glass wool core of the tiles is tested and classified as non-combustible according to EN ISO 1182. Europe. EN 13501-1. A2-s1,d0

Humidity Resistance: Class A, relative humidity 70% and 25°C, according to EN 13964:2014

Visual appearance: White Frost, nearest NCS colour sample S 0500-N, 85% light reflectance. Gloss < 1.

Cleanability: Daily dusting and vacuum cleaning. Weekly wet wiping.

Accessibility: The tiles are demountable.

Installation: Installed according to installation diagrams, installation guides and drawing aid. For information regarding minimum overall depth of system see quantity specification.

Mechanical properties: Additional live load has to be fixed to the soffit.

CE: Ecophon ceiling systems are CE marked according to the European harmonized standard EN13964:2014. CE marked construction products are covered by a Declaration of Performance (DOP) which enables customers and users to easily compare performance of products available on the European market.

Installation diagram in detail www.ecophon.com

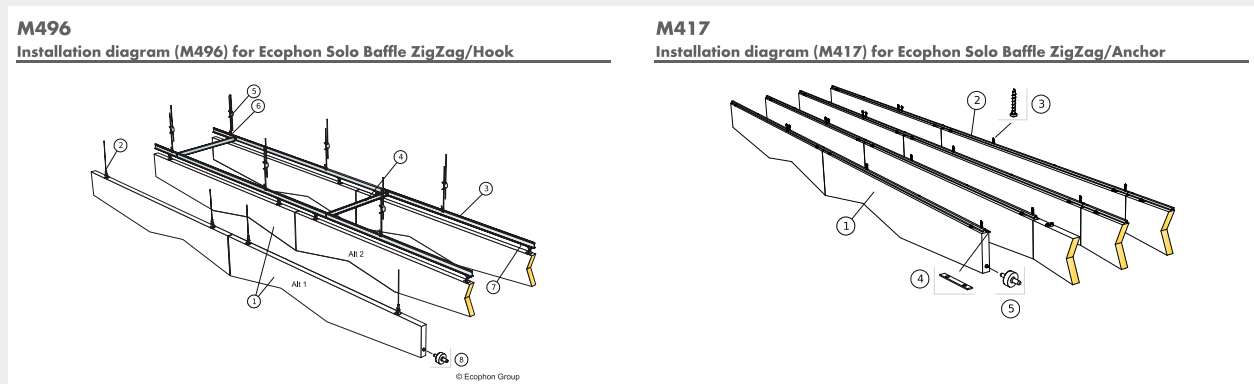

Ecophon Solo™ Baffle Wall

Acoustic: For acoustic data on the Baffle - please see Solo Baffle.

Indoor Air Quality: French VOC, A+. Finnish M1.

Environmental Footprint: Kg CO₂ equiv/m²: 8,07 From EPD in conformity with ISO 14025 / EN 15804

Circularity: Fully recyclable

Fire safety: The glass wool core of the tiles is tested and classified as non-combustible according to EN ISO 1182. Europe. EN 13501-1. A2-s1,d0

Humidity Resistance: Class A, relative humidity 70% and 25°C, according to EN 13964:2014

Visual appearance: White Frost, nearest NCS colour sample S 0500-N, 85% light reflectance. Gloss < 1.

Cleanability: Daily dusting and vacuum cleaning. Weekly wet wiping.

Accessibility: The tiles are demountable.

Installation: Installed according to installation diagrams, installation guides and drawing aid. For information regarding minimum overall depth of system see quantity specification.

Mechanical properties: Additional live load has to be fixed to the soffit.

CE: Ecophon ceiling systems are CE marked according to the European harmonized standard EN13964:2014. CE marked construction products are covered by a Declaration of Performance (DOP) which enables customers and users to easily compare performance of products available on the European market.

Installation diagram in detail www.ecophon.com

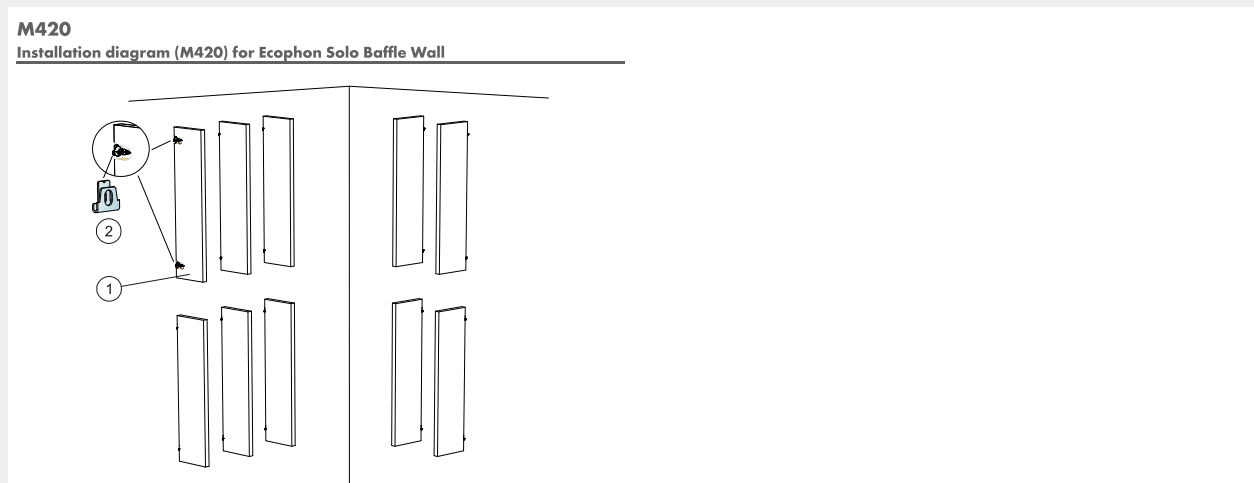



Ecophon Solo™ Steel

Acoustic

The values in the diagram refer to a single unit. If the units are arranged in a cluster with distances between units less than 0,5 meters, the Aeq per unit will be slightly reduced.

Sound Absorption:

Test results according to EN ISO 354.

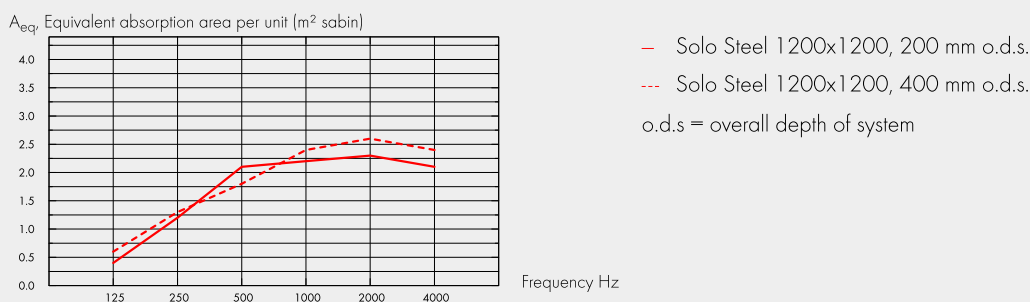

THK mm	o.d.s. mm	A _{eq} Equivalent absorption area per unit (m ² sabin)					
		125 Hz	250 Hz	500 Hz	1000 Hz	2000 Hz	4000 Hz
40	200	0.4	1.2	2.1	2.2	2.3	2.1
40	400	0.6	1.3	1.8	2.4	2.6	2.4

Indoor Air Quality: French VOC, A+.

Circularity: Fully recyclable

Fire safety: The glass wool core of the tiles is tested and classified as non-combustible according to EN ISO 1182. Europe. EN 13501-1. A2-s1,d0

Humidity Resistance: Class A, relative humidity 70% and 25°C, according to EN 13964:2014

Visual appearance: Light reflectance and nearest NCS colour sample for all the different colours: See Ecophon Colours and surfaces. (The tiles need to be installed in accordance with the installation guide in order to get optimal visual appearance).

Cleanability: Daily dusting and vacuum cleaning. Weekly wet wiping.

Accessibility: The tiles are demountable.

Installation: Installed according to installation diagrams, installation guides and drawing aid. For information regarding minimum overall depth of system see quantity specification.

Mechanical properties: No additional live load is allowed.

CE: Ecophon ceiling systems are CE marked according to the European harmonized standard EN13964:2014. CE marked construction products are covered by a Declaration of Performance (DOP) which enables customers and users to easily compare performance of products available on the European market.

M512

Installation diagram (M512) for Ecophon Solo Steel

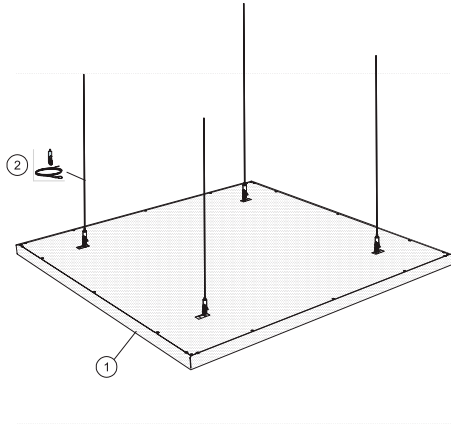

Ecophon®

SAINT-GOBAIN

A SOUND EFFECT ON PEOPLE

Ecophon is the leading supplier of acoustic solutions. We contribute to healthier indoor environments, improving quality of life, wellbeing and working performance. As evolution has adapted the human senses to a life outdoors, our focus is to bring the ideal acoustic environments of nature into our modern indoor spaces. We know they will have a sound effect on people.



The principles guiding our work are grounded in our Swedish heritage, where a human approach and a common responsibility for people's lives and future challenges come naturally.

Ecophon is part of the Saint-Gobain Group, a world leader in sustainable habitat solutions. This is also one of the top 100 industrial groups in the world, constantly innovating to make living spaces more comfortable and cost-efficient. Saint-Gobain offer solutions to the major challenges of energy efficiency and environmental protection. No matter what new needs emerge in the habitat and construction markets, the future is made of Saint-Gobain.



www.ecophon.com/uk